

CentreCOM[®] GS970EMX Series

Gigabit Layer 3 Lite Access Switches with 10 Gigabit Uplinks

GS970EMX/10

GS970EMX/20

GS970EMX/28

GS970EMX/52

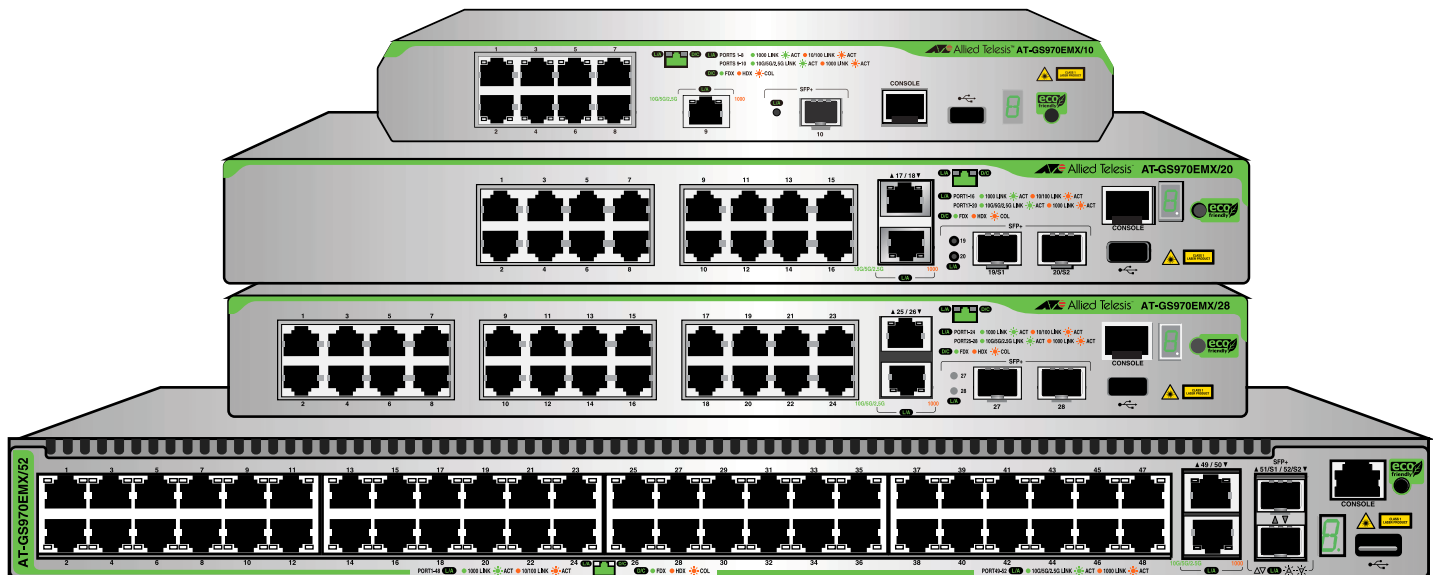

Installation Guide for Standalone Switches

Copyright © 2023 Allied Telesis, Inc.

All rights reserved. No part of this publication may be reproduced without prior written permission from Allied Telesis, Inc.

Allied Telesis, VCStack, Allied Telesis logo, and CentreCOM are trademarks or registered trademarks of Allied Telesis, Incorporated. All other product names, company names, logos or other designations mentioned herein are trademarks or registered trademarks of their respective owners.

Allied Telesis, Inc. reserves the right to make changes in specifications and other information contained in this document without prior written notice. The information provided herein is subject to change without notice. In no event shall Allied Telesis, Inc. be liable for any incidental, special, indirect, or consequential damages whatsoever, including but not limited to lost profits, arising out of or related to this manual or the information contained herein, even if Allied Telesis, Inc. has been advised of, known, or should have known, the possibility of such damages.

Electrical Safety and Emissions Standards

This product meets the following standards.

U.S. Federal Communications Commission
<p>Radiated Energy</p> <p>Note: This equipment has been tested and found to comply with the limits for a Class A digital device pursuant to Part 15 of FCC Rules. These limits are designed to provide reasonable protection against harmful interference when the equipment is operated in a commercial environment. This equipment generates, uses, and can radiate radio frequency energy and, if not installed and used in accordance with this instruction manual, may cause harmful interference to radio communications. Operation of this equipment in a residential area is likely to cause harmful interference in which case the user will be required to correct the interference at his own expense.</p> <p>Note: Modifications or changes not expressly approved of by the manufacturer or the FCC, can void your right to operate this equipment.</p>

Industry Canada
<p>This Class A digital apparatus complies with Canadian ICES-003.</p> <p>Cet appareil numérique de la classe A est conforme à la norme NMB-003 du Canada.</p>



Warning

In a domestic environment this product may cause radio interference in which case the user may be required to take adequate measures.. E84

Electrical Safety: EN 62368-1 (UL/EN/IEC)



Laser Safety EN 60825-1

Table 1 lists the product certificates.

Table 1. Product Certifications

Additional Certificates	CISPR Class A (Comité International Spécial des Perturbations Radioélectriques) RoHS Compliant
Australia/New Zealand	RCM (Regulatory Compliance Mark)
Common Criteria	NIAP (National Information Assurance Partnership)

Table 1. Product Certifications (Continued)

European Economic Area (EEA)	<p>CE (Conformité Européenne)</p> <p>WEEE (Waste Electrical and Electronic Equipment)</p> <p>RoHS (EU 1025/863) (Restriction of Hazardous Substances)</p>
European Standards (EN)	<p>EMC (Immunity): EN 55024, EN 55035</p> <p>Laser Safety: EN 60825-1</p> <p>EN 55032 Class A, EN 61000-3-2, EN 61000-3-3</p>
India	<p>TEC (Telecommunications Engineering Center)</p>
Japan	<p>VCCI Class A (Voluntary Control Council for Interference)</p>
Mexico	<p>NOM (Normas Oficiales Mexicanas)</p>
North America	<p>FCC Class A</p> <p>Laser Safety: EN 60825-1</p> <p>cUL_{US}</p> <p>Energy Star</p>
United Kingdom	<p>UKCA (UK Conformity Assessment)</p>

Translated Safety Statements

Important: Safety statements with the  symbol are translated into multiple languages in **Translated Safety Statements** at alliedtelesisis.com/library/search.

Übersetzte Sicherheitshinweise

Wichtig: Sicherheitshinweise mit dem -Symbol werden in **Translated Safety Statements** bei alliedtelesisis.com/library/search in mehrere Sprachen übersetzt.

Declaraciones de seguridad traducidas

Importante: Las declaraciones de seguridad con el símbolo  se traducen a varios idiomas en **Translated Safety Statements** en alliedtelesisis.com/library/search.

Consignes de sécurité traduites

Important: Les déclarations de sécurité avec le symbole  sont traduites en plusieurs langues en **Translated Safety Statements** sur alliedtelesisis.com/us/en/library/search.

Dichiarazioni di sicurezza tradotte

Importante: Le dichiarazioni di sicurezza con il simbolo  sono tradotte in più lingue in **Translated Safety Statements** su alliedtelesisis.com/library/search.

Översatta säkerhetsföklaringar

Viktig: Säkerhetsföreskrifter med -symbolen översätts till flera språk på **Translated Safety Statements** vid alliedtelesisis.com/library/search.

Contents

Preface	13
Document Conventions	14
Contacting Allied Telesis	15
Chapter 1: Overview	17
Front and Back Panels	18
Features	21
10/100/1000Mbps Copper Ports	21
1/2.5/5/10Gbps Multi-Gigabit Copper Ports	21
1/10Gbps SFP+ Ports	21
Port and System LEDs	22
Installation Options	22
MAC Address Table	22
Management Software and Interfaces	23
Energy Savings	23
10/100/1000Mbps Copper Ports	24
1/2.5/5/10Gbps Multi-Gigabit Copper Ports	26
SFP+ Ports	28
Port LEDs	29
10/100/1000Mbps Copper Port LEDs	29
1/2.5/5/10Gbps Multi-Gigabit Copper Port LEDs	31
1/10Gbps SFP+ Port LEDs	32
eco-friendly Button	34
Switch ID LED	35
USB Port	37
Console Port	38
Power Supply and Power Savings Features	39
Chapter 2: Beginning the Installation	41
Reviewing Safety Precautions	42
Choosing a Site for the Switch	46
Site Requirements	46
Enclosure Requirements	47
Unpacking the Switch	48
Installation Options	51
GS970EMX/10 Switch	51
GS970EMX/20 Switch	52
GS970EMX/28 Switch	53
GS970EMX/52 Switch	54
Hardware Options	55
RKMT-J05 Equipment Rack Brackets Kit	55
BRKT-J23 Wall Brackets Kit	56
RKMT-J13 Equipment Rack Brackets Kit	56
BRKT-J24 Wall Brackets Kit	57
Recording the Serial Number and MAC Address	58
Installing the Switch on a Table	59
Chapter 3: Installing the GS970EMX/10 Switch in an Equipment Rack	63
Introduction	64
Installing the GS970EMX/10 Switch	66

Chapter 4: Installing the GS970EMX/20 Switch in an Equipment Rack	71
Introduction.....	72
Installing the GS970EMX/20 Switch.....	73
Chapter 5: Installing the GS970EMX/28 Switch in an Equipment Rack	77
Introduction.....	78
Installing the GS970EMX/28 Switch.....	79
Chapter 6: Installing the GS970EMX/52 Switch in an Equipment Rack	81
Introduction.....	82
Installing the GS970EMX/52 Switch.....	83
Chapter 7: Installing the GS970EMX/10 Switch on a Wall	85
Introduction.....	86
Installation Guidelines	88
Installing the GS970EMX/10 Switch.....	89
Chapter 8: Installing GS970EMX/20, GS970EMX/28, and GS970EMX/52 Switches on a Wall	95
Installation Guidelines	96
Plywood Base for a Wall with Wooden Studs.....	99
Installing the Switch.....	101
Chapter 9: Verifying the Switch	105
Powering On the Switch	106
Starting a Management Session	108
Through the Console Port	108
With a DHCP or DHCPv6 Server.....	110
Without a DHCP or DHCPv6 Server.....	111
Displaying the Hardware Status and Disabling VCStack	113
Chapter 10: Cabling Copper and SFP+ Ports	117
Cabling Copper Ports	118
Guidelines to Handling SFP and SFP+ Transceivers.....	119
Installing 1Gbps SFP and 10Gbps SFP+ Transceivers.....	120
Installing SP10TW Direct Connect Twinax Cables in SFP+ Ports	123
Chapter 11: Troubleshooting	125
Appendix A: Technical Specifications	129
Physical Specifications	130
Environmental Specifications	134
Power Specifications	135
Certifications.....	137
RJ-45 Copper Port Pinouts.....	139
RJ-45 Style Serial Console Port Pinouts	140

Figures

Figure 1: Front Panel of the GS970EMX/10 Switch	18
Figure 2: Front Panel of the GS970EMX/20 Switch	18
Figure 3: Front Panel of the GS970EMX/28 Switch	19
Figure 4: Front Panel of the GS970EMX/52 Switch	19
Figure 5: Back Panels	20
Figure 6: Speed/Activity and Duplex Mode LEDs for the 10/100/1000Mbps Copper Ports.....	29
Figure 7: Speed/Activity LEDs for the 1/2.5/5/10Gbps Multi-Gigabit Copper Ports.....	31
Figure 8: Speed/Activity LEDs for the 1/10Gbps SFP+ Ports.....	32
Figure 9: Switch ID LED	35
Figure 10: Switch ID LED with eco-friendly Mode Off (Port LEDs On).....	35
Figure 11: Switch ID LED with eco-friendly Mode On (Port LEDs Off).....	36
Figure 12: Accessory Items Included with the GS970EMX/10 and GS970EMX/20 Switches.....	48
Figure 13: Accessory Items Included with the GS970EMX/28 Switch.....	49
Figure 14: Accessory Items Included with the GS970EMX/52 Switch.....	50
Figure 15: Installation Options for the GS970EMX/10 Switch	51
Figure 16: Installation Options for the GS970EMX/20 Switch	52
Figure 17: Installation Options for the GS970EMX/28 Switch	53
Figure 18: Installation Options for the GS970EMX/52 Switch	54
Figure 19: RKMT-J05 Equipment Rack Brackets Kit for the GS970EMX/10 Switch	55
Figure 20: BRKT-J23 Wall Brackets Kit for the GS970EMX/10 Switch	56
Figure 21: RKMT-J13 Equipment Rack Brackets Kit for the GS970EMX/20 Switch	56
Figure 22: BRKT-J24 Wall Brackets Kit for the GS970EMX/20 and GS970EMX/28 Switches	57
Figure 23: Serial Number and MAC Address Labels.....	58
Figure 24: Switch Installation on a Table.....	59
Figure 25: Unsupported Table Installations.....	59
Figure 26: Attaching the Bumper Feet on GS970EMX/10, GS970EMX/20, and GS970EMX/28 Switches	60
Figure 27: Attaching Bumper Feet on the GS970EMX/52 Switch	61
Figure 28: GS970EMX/10 Switch in an Equipment Rack with the RKMT-J05 Brackets Kit	64
Figure 29: GS970EMX/10 Switch with RKMT-J05 Cable Trays	65
Figure 30: Attaching the RKMT-J05 Handles to the Short Brackets.....	66
Figure 31: Attaching the Short RKMT-J05 Brackets to the Long Brackets.....	67
Figure 32: Attaching the RKMT-J05 Cord Trays to the Long Brackets.....	68
Figure 33: Attaching the RKMT-J05 Brackets to the Switch.....	69
Figure 34: Attaching the GS970EMX/10 Switch to an Equipment Rack.....	70
Figure 35: GS970EMX/20 Switch with RKMT-J13 Equipment Rack Brackets Kit.....	72
Figure 36: Attaching the Handles to the RKMT-J13 Brackets	73
Figure 37: Attaching the Extenders to the RKMT-J13 Brackets	74
Figure 38: Attaching the RKMT-J13 Brackets to the GS970EMX/20 Switch.....	74
Figure 39: Securing the GS970EMX/20 Switch in a Standard 19-inch Equipment Rack	75
Figure 40: GS970EMX/28 Switch Installed in a Standard 19-inch Equipment Rack	78
Figure 41: Attaching the Equipment Rack Brackets to the GS970EMX/28 Switch.....	79
Figure 42: Securing the GS970EMX/28 Switch in a Standard 19-inch Equipment Rack	80
Figure 43: Bracket Screw Holes on the GS970EMX/52 Switch.....	82
Figure 44: Equipment Rack Bracket Positions for the GS970EMX/52 Switch.....	82
Figure 45: Attaching the Equipment Rack Brackets to the GS970EMX/52 Switch.....	83
Figure 46: Securing the GS970EMX/52 Switch in a Standard 19-inch Equipment Rack	84
Figure 47: GS970EMX/10 Switch with Two BRKT-J23 Wall Brackets	86
Figure 48: GS970EMX/10 Switch with Four BRKT-J23 Wall Brackets.....	87
Figure 49: Unsupported Wall Installation with Front Panel Facing Down.....	87

Figure 50: Marking the Screw Holes for Two BRKT-J23 Brackets90

Figure 51: Marking the Screw Holes for Four BRKT-J23 Brackets.....91

Figure 52: Attaching the Bottom BRKT-J23 Brackets to the Wall.....92

Figure 53: Sliding the Switch into the BRKT-J23 Brackets.....93

Figure 54: Attaching the Top BRKT-J23 Brackets to the Wall.....94

Figure 55: GS970EMX/20 and GS970EMX/28 Switches on a Wall with the BRKT-J24 Brackets Kit96

Figure 56: GS970EMX/52 Switch on a Wall96

Figure 57: Unsupported Wall Installation of the GS970EMX/20, GS970EMX/28, and GS970EMX/52 Switches.....97

Figure 58: GS970EMX Switch on a Wall with a Plywood Base99

Figure 59: Steps to Installing GS970EMX Switches on a Plywood Base100

Figure 60: Attaching the BRKT-J24 Wall Brackets to the GS970EMX/20 and GS970EMX/28 Switches.....102

Figure 61: Attaching the Wall/Equipment Rack Brackets to the GS970EMX/52 Switch.....102

Figure 62: Attaching the Wall/Equipment Rack Brackets to the GS970EMX/52 Switch (continued).....103

Figure 63: Marking the Locations of the Bracket Holes104

Figure 64: Installing the Power Cord Retaining Clip106

Figure 65: Connecting the AC Power Cord.....106

Figure 66: Lowering the Power Cord Retaining Clip.....107

Figure 67: Connecting the Power Cord to an AC Power Source107

Figure 68: Management Cable Included with Switch.....108

Figure 69: VT-Kit3 Management Cable108

Figure 70: , Local Management with the VT-Kit3 Management Cable109

Figure 71: Moving to the Global Configuration Mode113

Figure 72: Confirmation Prompt for the NO STACK ENABLE Command114

Figure 73: Returning to the Privileged Exec Mode114

Figure 74: Saving the Changes with the WRITE Command.....114

Figure 75: Installing an SFP+ Transceiver.....120

Figure 76: Removing the Dust Cover from an SFP+ Transceiver121

Figure 77: Positioning the SFP+ Handle in the Upright Position121

Figure 78: Connecting a Fiber Optic Cable to an SFP or SFP+ Transceiver122

Figure 79: Installing an SP10TW Cable.....123

Figure 80: Dimensions of the GS970EMX/10 Switch130

Figure 81: Dimensions of GS970EMX/20 and GS970EMX/28 Switches.....131

Figure 82: Dimensions of the GS970EMX/52 Switch131

Figure 83: Bracket Screw Holes on GS970EMX/20 and GS970EMX/28 Switches132

Figure 84: Bracket Screw Holes on the GS970EMX/52 Switch.....133

Figure 85: Pin Layout for the RJ-45 Copper Ports (Front View)139

Tables

Table 1: Product Certifications	3
Table 2: Specifications of the 10/100/1000Mbps Copper Ports	24
Table 3: Specifications of the 1/2.5/5/10Gbps Multi-Gigabit Copper Ports	26
Table 4: Speed/Activity LEDs for the 10/100/1000Mbps Copper Ports	29
Table 5: Duplex Mode LEDs for the 10/100/1000Mbps Copper Ports	30
Table 6: Speed/Activity LEDs for the 1/2.5/5/10Gbps Multi-Gigabit Copper Ports	31
Table 7: Speed/Activity LEDs for the 1/10Gbps SFP+ Ports	33
Table 8: Product Dimensions (H x W x D)	130
Table 9: Switch Weights	132
Table 10: Ventilation Requirements	132
Table 11: Environmental Specifications	134
Table 12: Maximum Power Consumption	135
Table 13: Input Voltages	135
Table 14: Heat Dissipation	136
Table 15: Product Certifications	137
Table 16: Pin Signals for Copper Ports	139
Table 17: RJ-45 Style Serial Console Port Pin Signals	140

Preface

This guide contains the hardware installation instructions for the CentreCOM® GS970EMX Series of Gigabit Layer 3 Lite Ethernet Access switches as standalone units. The preface contains the following sections:

- “Document Conventions” on page 14
- “Contacting Allied Telesis” on page 15

The GS970EMX Switches support Virtual Chassis Stacking (VCStack™). The feature allows you manage multiple switches as a single unit and add redundancy to your network topology by distributing functions across multiple devices. For installation instructions, refer to the *CentreCOM GS970EMX Series Installation Guide for Virtual Chassis Stacking*.

Document Conventions

This document uses the following conventions:

Note

Notes provide additional information.



Caution

Cautions inform you that performing or omitting a specific action may result in equipment damage or loss of data.



Warning

Warnings inform you that performing or omitting a specific action may result in bodily injury.

Contacting Allied Telesis

For assistance with this product, you may contact Allied Telesis technical support on the Services & Support section of the Allied Telesis web site at **www.alliedtelesis.com/services-support**. The page has links to the following services:

- ❑ Helpdesk (Support Portal) - Log onto Allied Telesis interactive support center to search for answers to your questions in our knowledge database, check support tickets, learn about Return Merchandise Authorizations (RMAs), and contact Allied Telesis technical experts.
- ❑ Software Downloads - Download the latest software releases for your products.
- ❑ Licensing - Register and obtain License keys to activate your products.
- ❑ Product Documents - View the most recent installation guides, user guides, software release notes, white papers and data sheets for your product.
- ❑ Warranty - View a list of products to see if Allied Telesis warranty applies to the product you purchased and register your warranty.
- ❑ Allied Telesis Helpdesk - Contact a support representative.

Chapter 1

Overview

This chapter contains the following sections:

- ❑ “Front and Back Panels” on page 18
- ❑ “Features” on page 21
- ❑ “10/100/1000Mbps Copper Ports” on page 24
- ❑ “1/2.5/5/10Gbps Multi-Gigabit Copper Ports” on page 26
- ❑ “SFP+ Ports” on page 28
- ❑ “Port LEDs” on page 29
- ❑ “eco-friendly Button” on page 34
- ❑ “Switch ID LED” on page 35
- ❑ “USB Port” on page 37
- ❑ “Console Port” on page 38
- ❑ “Power Supply and Power Savings Features” on page 39

Front and Back Panels

Figure 1 shows the front panel of the GS970EMX/10 Switch.

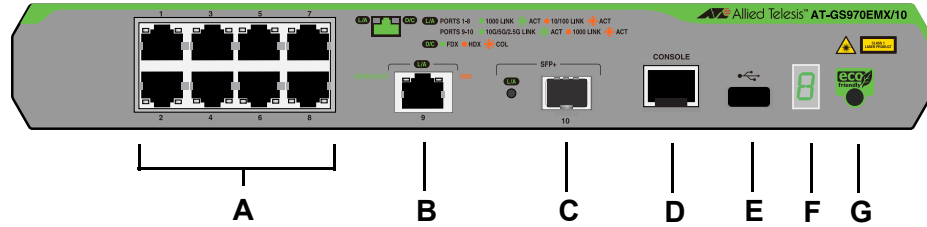

- A. Eight 10/100/1000Mbps Copper Ports**
- B. One 1/2.5/5/10Gbps Multi-Gigabit Copper Port**
- C. One 1/10Gbps SFP+ Transceiver Port**
- D. One Local Management Console Port**
- E. One USB Flash Drive Port**
- F. Switch ID LED**
- G. eco-friendly Button**

Figure 1. Front Panel of the GS970EMX/10 Switch

Figure 2 shows the front panel of the GS970EMX/20 Switch.

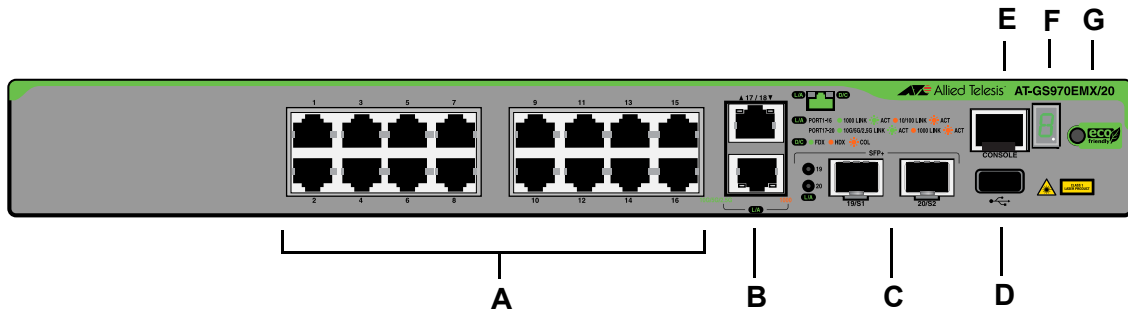

- A. Sixteen 10/100/1000Mbps Copper Ports**
- B. Two 1/2.5/5/10Gbps Multi-Gigabit Copper Ports**
- C. Two 1/10Gbps SFP+ Transceiver Ports**
- D. One USB Flash Drive Port**
- E. One Local Management Console Port**
- F. Switch ID LED**
- G. eco-friendly Button**

Figure 2. Front Panel of the GS970EMX/20 Switch

Figure 3 shows the front panel of the GS970EMX/28 Switch.

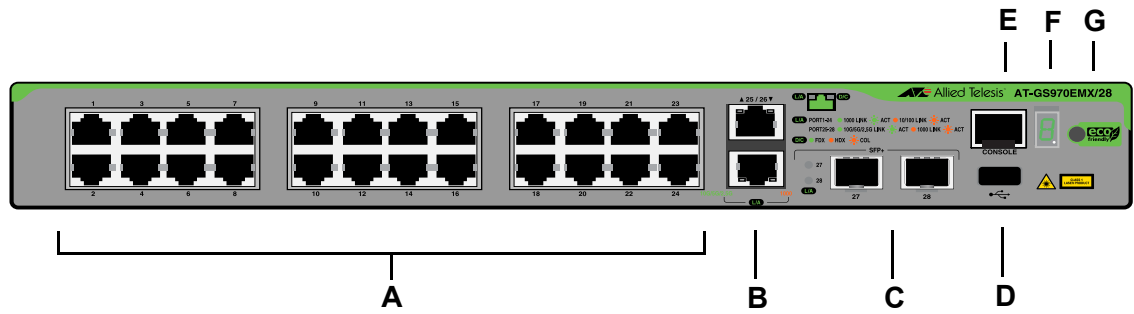

- A. Twenty-four 10/100/1000Mbps Copper Ports**
- B. Two 1/2.5/5/10Gbps Multi-Gigabit Copper Ports**
- C. Two 1/10Gbps SFP+ Transceiver Ports**
- D. One USB Flash Drive Port**
- E. One Local Management Console Port**
- F. Switch ID LED**
- G. eco-friendly Button**

Figure 3. Front Panel of the GS970EMX/28 Switch

Figure 4 shows the front panel of the GS970EMX/52 Switch.

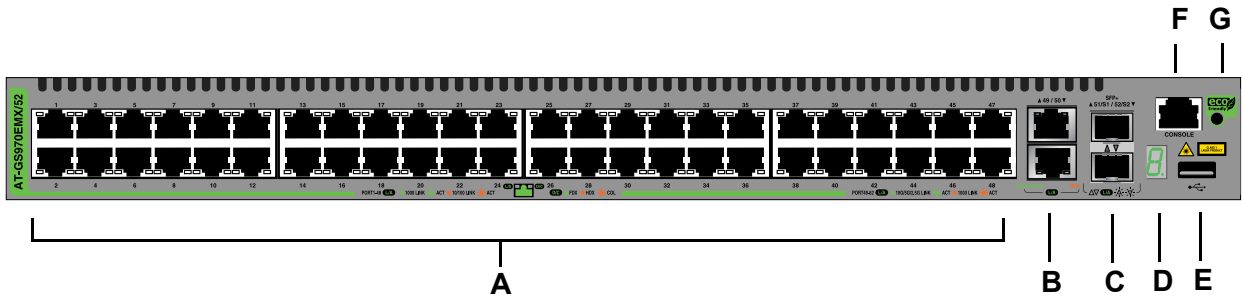

- A. Forty-eight 10/100/1000Mbps Copper Ports**
- B. Two 1/2.5/5/10Gbps Multi-Gigabit Copper Ports**
- C. Two 1/10Gbps SFP+ Transceiver Ports**
- D. Switch ID LED**
- E. One USB Flash Drive Port**
- F. One Local Management Console Port**
- G. eco-friendly Button**

Figure 4. Front Panel of the GS970EMX/52 Switch

Figure 5 illustrates the back panels.

GS970EMX/10 Switch



GS970EMX/20 and GS970EMX/28 Switches



GS970EMX/52 Switch



Figure 5. Back Panels

Note

The GS970EMX/10, GS970EMX/20, and GS970EMX/28 Switches are fanless. The GS970EMX/52 Switch has a single fan inside the back panel. Its ventilation direction is from front to back, with the fan drawing air out of the device.

Features

10/100/1000Mbps Copper Ports

The basic features of the 10/100/1000Mbps copper ports are listed here:

- 10Base-T, 100Base-TX, and 1000Base-T compliant
- IEEE 802.3u Auto-Negotiation compliant
- Auto-MDI/MDIX
- 100 meters (328 feet) maximum operating distance
- IEEE 802.3x flow control in 10/100Base-TX full-duplex mode
- IEEE 802.3x backpressure in 10/100Base-TX half-duplex mode
- Speed/activity LEDs
- Jumbo frames up to 12288 bytes
- RJ-45 connectors

1/2.5/5/10Gbps Multi-Gigabit Copper Ports

The basic features of the 1/2.5/5/10Gbps Multi-Gigabit copper ports are listed here:

- 1000Base-T, 2.5GBase-T, 5GBase-T, and 10GBase-T compliant
- IEEE 802.3bz for 2.5GBase-T and 5GBase-T
- Auto-Negotiation for speed
- 100 meters (328 feet) maximum operating distance per port
- Full-duplex mode only
- Speed/activity LEDs
- RJ-45 connectors

1/10Gbps SFP+ Ports

The SFP+ ports support the following types of 1Gbps SFP and 10Gbps SFP+ transceivers:

- 1Gbps SFP 1000Base-SX/LX transceivers
- 1Gbps SFP 1000Base-LX single-port BiDi transceivers
- 1Gbps SFP 1000Base-ZX transceivers
- 10Gbps SFP+ 10GBase-SR/LR fiber optic transceivers
- 10Gbps SFP+ 1-meter AT-SP10TW1 and 3-meter AT-SP10TW3 direct connect twinax cables with SFP+ transceiver-style connectors
- 10Gbps SFP+ single-port BiDi transceivers
- AT-SP10TM 1/2.5/5/10Gbps copper transceiver

Note

The SFP+ ports do not support 100Mbps 100Base-FX transceivers.

Note

The ports support full-duplex mode only.

Note

SFP and SFP+ transceivers are sold separately. Refer to the product's data sheet on the Allied Telesis website for a list of supported transceivers.

Note

The switches do not support the 7-meter AT-SP10TW7 direct connect twinax cable.

Port and System LEDs

Here are the port and system LEDs:

- Speed/activity and duplex mode LEDs for the 10/100/1000Mbps copper ports
 - Speed/activity LEDs for the 1/2.5/5/10Gbps Multi-Gigabit copper ports
 - Speed/activity LEDs for the SFP+ ports
 - Switch ID number LED
-

Note

Refer to "Port LEDs" on page 29.

Installation Options

Here are the installation options for the switches:

- Desk or tabletop
- Standard 19-inch equipment rack
- Wood or concrete wall

MAC Address Table

Here are the basic features of the MAC address tables in the switches:

- Storage capacity of 16,384 dynamic entries
- Storage capacity of 256 static entries
- Automatic learning and aging

Management Software and Interfaces

Here are the management software and interfaces:

- AlliedWare Plus Management Software
- Local management through the Console port
- Remote Telnet and Secure Shell management
- Remote HTTP and HTTPS web browser management
- Command line interface
- Autonomous Management Framework
- Vista Manager EX
- AMF-Security
- SNMPv1, v2c, and v3

Energy Savings

Here are energy saving features:

- eco-friendly button for turning on and off the port LEDs
- IEEE 802.3az Energy-Efficient Ethernet (EEE)

10/100/1000Mbps Copper Ports

Table 1 lists the specifications of the 10/100/1000Mbps copper ports.

Table 1. Specifications of the 10/100/1000Mbps Copper Ports

Feature	Description
Speeds	Port speeds are listed here: <ul style="list-style-type: none"> - 10Mbps (IEEE802.3 10Base-T) - 100Mbps (IEEE802.3u 100Base-TX) - 1Gbps (IEEE802.3ab 1000Base-T) Speeds are set manually or with IEEE 802.3u Auto-Negotiation.
Duplex modes	Duplex modes are listed here: <ul style="list-style-type: none"> - Half- or full-duplex mode at 10/100Mbps - Full-duplex mode only at 1000Mbps Duplex modes are set manually or with IEEE 802.3u Auto-Negotiation. <p>Speed and duplex mode settings of copper ports can be set independently of each other. For instance, ports can be configured such that their speeds are set manually while their duplex modes are set through Auto-Negotiation.</p>
Wiring	Auto-MDI/MDIX at 10/100/1000Mbps (IEEE 802.3ab-compliant)
Maximum Distance	100 meters (328 feet)
Cable	Cable requirements are listed here: <ul style="list-style-type: none"> - 10/100Mbps - Standard TIA/EIA 568-B-compliant Category 3 unshielded cable or better. - 1Gbps - Standard TIA/EIA 568-B-compliant Category 5 or Category 5e unshielded cable or better.

Table 1. Specifications of the 10/100/1000Mbps Copper Ports (Continued)

Feature	Description
Additional Features	Additional features are listed here: <ul style="list-style-type: none"> - 8-pin RJ-45 connectors - Backpressure flow control supported at half-duplex mode - Non-blocking, wire speed supported at all speeds. - Jumbo frames up to 12288 bytes - 2MB packet buffer

For port pinouts, refer to “RJ-45 Copper Port Pinouts” on page 139.

Note

Copper ports must be set to Auto-Negotiation, the default, to function at 1000Mbps. The network devices must be IEEE 802.3u compliant.

Note

Copper ports that are connected to devices that do not support Auto-Negotiation should not use Auto-Negotiation to set speed and duplex mode. Otherwise, a speed or duplex mode mismatch might occur between the devices, resulting in reduced performance. You should set speed and duplex mode manually on copper ports that are connected to devices that do not support Auto-Negotiation.

1/2.5/5/10Gbps Multi-Gigabit Copper Ports

The GS970EMX/10 Switch has one Multi-Gigabit copper port. The GS970EMX/20, GS970EMX/28, and GS970EMX/52 Switches have two Multi-Gigabit copper ports. Table 2 lists the port specifications.

Table 2. Specifications of the 1/2.5/5/10Gbps Multi-Gigabit Copper Ports

Specification	Description
Port Speed	<p>Here are the supported speeds:</p> <ul style="list-style-type: none"> - 1Gbps (IEEE802.3ab) - 2.5Gbps (IEEE 802.3bz) - 5Gbps (IEEE 802.3bz) - 10Gbps (IEEE 802.3an) <p>You can set port speed with Auto-Negotiation or manually. Guidelines are given here:</p> <ul style="list-style-type: none"> - 1Gbps and 10Gbps can be set either manually or with Auto-Negotiation. - 2.5Gbps and 5Gbps must be set with Auto-Negotiation. - The default setting is Auto-Negotiation.
Duplex Mode	Full-duplex only
Maximum Distance	100 meters (328 feet)
Connector	8-pin RJ-45
Cable Requirements	<ul style="list-style-type: none"> - 1/2.5/5Gbps - Standard TIA/EIA 568-A-compliant Category 5 or TIA/EIA 568-B-compliant Enhanced Category 5 (Cat 5e) unshielded cabling. - 10Gbps -Standard TIA/EIA 568-C-compliant Category 6a unshielded cabling.

Table 2. Specifications of the 1/2.5/5/10Gbps Multi-Gigabit Copper Ports

Specification	Description
Additional Features	Additional features are listed here: <ul style="list-style-type: none"> - 8-pin RJ-45 connectors - Non-blocking, wire speed supported at all speeds - Supports up to 12KB jumbo frames at 1/5/10Gbps - Supports up to 10KB jumbo frames at 2.5Gbps - 2MB packet buffer

Note

Network devices connected to Multi-Gigabit ports must be IEEE 802.3u compliant.

SFP+ Ports

The GS970EMX/10 Switch has one SFP+ port. The GS970EMX/20, GS970EMX/28, and GS970EMX/52 Switches have two SFP+ ports. The ports support the following types of 1Gbps SFP and 10Gbps SFP+ transceivers:

- ❑ 1Gbps SFP 1000Base-SX/LX transceivers
- ❑ 1Gbps SFP 1000Base-LX single-port BiDi transceivers
- ❑ 1Gbps SFP 1000Base-ZX transceivers
- ❑ 10Gbps SFP+ 10GBase-SR/LR fiber optic transceivers
- ❑ 10Gbps SFP+ 1-meter AT-SP10TW1 and 3-meter AT-SP10TW3 direct connect twinax cables with SFP+ transceiver-style connectors
- ❑ 10Gbps SFP+ single-port BiDi transceivers
- ❑ AT-SP10TM 1/2.5/5/10Gbps copper port transceiver

You can use the ports to connect switches to other network devices over large distances, build a high-speed backbone network between network devices, or connect high-speed devices, such as servers, to your network.

Note

The SFP+ ports do not support 100Mbps 100Base-FX transceivers.

Note

The ports support full-duplex mode only.

Note

SFP and SFP+ transceivers are sold separately. Refer to the product's data sheet for a list of supported transceivers.

Note

The switches do not support the 7-meter SFP+ AT-SP10TW7 direct connect twinax cable.

Port LEDs

This section describes the copper, Multi-Gigabit, and SFP+ port LEDs.

10/100/1000Mbps Copper Port LEDs

The 10/100/1000Mbps copper ports have two LEDs that display the following information:

- Speed/activity
- Duplex mode

The LEDs are identified in Figure 6.

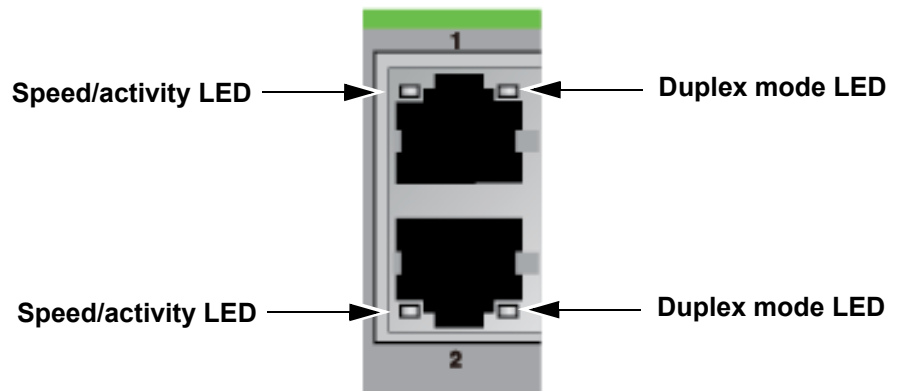

Figure 6. Speed/Activity and Duplex Mode LEDs for the 10/100/1000Mbps Copper Ports

Table 3 and Table 4 on page 30 define the LEDs.

Table 3. Speed/Activity LEDs for the 10/100/1000Mbps Copper Ports

State	Description
Solid Green	The port has established a link at 1Gbps to a network device.
Flashing Green	The port is transmitting or receiving network packets at 1Gbps.
Solid Amber	The port has established a link at 10 or 100Mbps to a network device.
Flashing Amber	The port is transmitting or receiving network packets at 10 or 100Mbps.

Table 3. Speed/Activity LEDs for the 10/100/1000Mbps Copper Ports

State	Description
Off	Possible causes of this state are listed here: <ul style="list-style-type: none"> - The port has not established a link with another network device. - The LEDs are turned off. To turn on the LEDs, use the eco-friendly button.

Table 4 describes the duplex mode LEDs for the 10/100/1000Mbps copper ports.

Table 4. Duplex Mode LEDs for the 10/100/1000Mbps Copper Ports

State	Description
Solid Green	The port is operating in full duplex mode.
Solid Amber	The port is operating in half duplex mode.
Flashing Amber	The port is operating in half duplex mode, with collisions.
Off	Possible causes of this state are listed here: <ul style="list-style-type: none"> - The port has not established a link with another network device. - The LEDs are turned off. To turn on the LEDs, use the eco-friendly button.

1/2.5/5/10Gbps Multi-Gigabit Copper Port LEDs

The 1/2.5/5/10Gbps Multi-Gigabit copper ports have two LEDs that display speed/activity information. Refer to Figure 7.

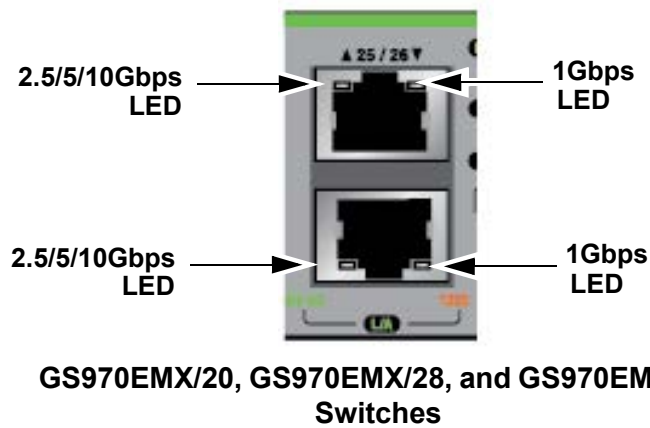
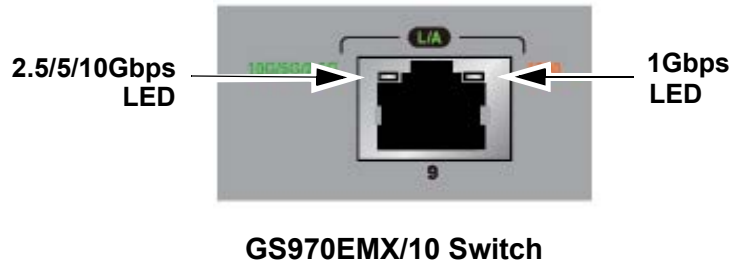

Figure 7. Speed/Activity LEDs for the 1/2.5/5/10Gbps Multi-Gigabit Copper Ports

Table 5 describes the LEDs.

Table 5. Speed/Activity LEDs for the 1/2.5/5/10Gbps Multi-Gigabit Copper Ports

State	Description
Solid Green (left LED)	The port has established a link at 2.5Gbps, 5Gbps, or 10Gbps to a network device.
Flashing Green (left LED)	The port is transmitting or receiving data at 2.5Gbps, 5Gbps, or 10Gbps.
Solid Amber (right LED)	The port has established a link at 1Gbps to a network device.
Flashing Amber (right LED)	The port is transmitting or receiving data at 1Gbps.

Table 5. Speed/Activity LEDs for the 1/2.5/5/10Gbps Multi-Gigabit Copper Ports (Continued)

State	Description
Off	Possible causes of this state are listed here: <ul style="list-style-type: none"> - The port has not established a link with another network device. - The LEDs are turned off. To turn on the LEDs, use the eco-friendly button.

1/10Gbps SFP+ Port LEDs

The 1/10Gbps SFP+ ports have one LED that displays speed/activity information. Refer to Figure 8.



GS970EMX/10 Switch



GS970EMX/20 and GS970EMX/28 Switches



GS970EMX/52 Switch

Figure 8. Speed/Activity LEDs for the 1/10Gbps SFP+ Ports

Table 6 describes the LED.

Table 6. Speed/Activity LEDs for the 1/10Gbps SFP+ Ports

State	Description
Solid Amber	The port has established a link at 1Gbps to a network device.
Flashing Amber	The port is transmitting or receiving data at 1Gbps.
Solid Green	The port has established a link at 10Gbps to a network device.
Flashing Green	The port is transmitting or receiving data at 10Gbps.
Off	Possible causes of this state are listed here: <ul style="list-style-type: none"> - The port has not established a link with another network device. - The LEDs are turned off. To turn on the LEDs, use the eco-friendly button.

eco-friendly Button

You use the eco-friendly button on the front panel of the switch to toggle the port LEDs on and off. You can conserve electricity by turning off the LEDs when you are not monitoring the device. When the LEDs are turned off, the switch is operating in the low power eco-friendly mode. Turning off the port LEDs does not interfere with the network operations of the switch. When the switches are operating in a stack, pressing the eco-friendly button toggles the eco-friendly mode on all the stack switches.

You can also toggle the port LEDs on and off with the ECOFRIENDLY LED and NO ECOFRIENDLY LED commands in the Global Configuration mode in the command line interface of the AlliedWare Plus management software, as follows:

- ❑ ECOFRIENDLY LED command - Turns off the LEDs.
- ❑ NO ECOFRIENDLY LED command - Turns on the LEDs.

The AlliedWare Plus management software has a command that blinks all the port LEDs so that you can quickly identify a specific unit among the devices in an equipment rack. It is the FINDME command. The command works even if the port LEDs are turned off.

The Switch ID LED is always on. It displays different information depending on whether the port LEDs are on or off. When the port LEDs are on, the Switch ID LED displays the ID number of the switch in a VCStack. When the switch is operating in the low power mode with the port LEDs off, the Switch ID LED indicates whether the switch is the master or member switch of a VCStack. Refer to “Switch ID LED” on page 35.

Note

Before checking or troubleshooting network connections to the ports on the switch, you should verify that the LEDs are on by pressing the eco-friendly button or issuing the NO ECOFRIENDLY LED command in the Global Configuration mode of the command line interface.

Switch ID LED

The Switch ID LED, shown in Figure 9, is for the VCStack feature for the GS970EMX/20, GS970EMX/28, and GS970EMX/52 Switches. You can manage up to four switches as a single unit. This simplifies network management and allows you to add redundancy to your network topology by distributing functions across multiple switches.



Figure 9. Switch ID LED

The LED displays different information depending on whether the low power eco-friendly mode is on or off. Refer to “eco-friendly Button” on page 34. Figure 10 lists the states of the LED when the eco-friendly mode is off and the port LEDs are on.

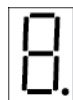

The switch is booting up.



The switch has detected a fault condition, such as overheating.



VCStack is disabled. The switch is a standalone unit.



VCStack is enabled. The switch has an ID number in the range of 1 to 4.



Flashing dot in the lower right corner indicates the switch is accessing a USB flash drive.

2666

Figure 10. Switch ID LED with eco-friendly Mode Off (Port LEDs On)

Note

The GS970EMX/10 Switch does not support the VCStack feature. It operates as a standalone device and displays “0” on the Switch ID LED when the eco-friendly mode is off.

Note

If the Switch ID LED displays “F” for a fault condition, use the SHOW SYSTEM ENVIRONMENT command in the command line interface of the AlliedWare Plus management software to identify the source of the problem.

Figure 11 illustrates the states of the LED when the eco-friendly mode is on and the port LEDs are off.



The switch is the master switch of a VCStack.



The switch is a standalone unit.



The switch is a member switch of a VCStack.

2667

Figure 11. Switch ID LED with eco-friendly Mode On (Port LEDs Off)

USB Port

You can use the USB port to store configuration files on flash drives to maintain a history of the switch's configurations, or to restore configuration files to the switch. You can also use the port and flash drives to quickly configure replacement units and update the AlliedWare Plus management software.

The port is USB 2.0 compatible.

Console Port

You use the Console port to configure the features and parameter settings of the switch with the command line interface in the AlliedWare Plus management software. This management is called local management because it is not conducted over your network. You have to be at the physical location of the switch. The Console port has these settings:

- Default baud rate: 9600 bps (Range is 9600 to 115200 bps)
- Data bits: 8
- Parity: None
- Stop bits: 1
- Flow control: None

Note

These settings are for a DEC VT100 or ANSI terminal, or an equivalent terminal emulation program.

Local management sessions require a management cable for connecting your computer or terminal to the Console port. Here are the cable guidelines:

- If your computer has an RS-232 port, you may use the management cable supplied with the switch. Refer to Figure 12 on page 48. The cable has RJ-45 and DB-9 connectors.
- If your computer has a USB port, you may need to purchase a USB-to-Serial converter that is compatible with its operating system. An example is the VT-Kit3 from Allied Telesis.

The Console port pinouts are provided in “RJ-45 Style Serial Console Port Pinouts” on page 140. For further information, refer to “Starting a Management Session” on page 108.

Power Supply and Power Savings Features

The GS970EMX Switches have one internal power supply. The power supply is not field-replaceable. Refer to “Power Specifications” on page 135 for the input voltage ranges.



Warning

Power cord is used as a disconnection device. To de-energize equipment, disconnect the power cord. *⚡* E3

The switches support the following power savings features:

- ❑ The switch supports IEEE 802.3az Energy-Efficient Ethernet (EEE). EEE is an energy saving feature that reduces power consumption during periods of no data activity. The switch saves electricity by placing the Ethernet circuitry in a special sleep mode when all the ports are inactive. When data activity resumes, the circuitry automatically resumes normal operations.
- ❑ The switches include the eco-friendly mode for turning off port LEDs to save power. Refer to “eco-friendly Button” on page 34.

Chapter 2

Beginning the Installation

The chapter contains the following sections:

- “Reviewing Safety Precautions” on page 42
- “Choosing a Site for the Switch” on page 46
- “Unpacking the Switch” on page 48
- “Installation Options” on page 51
- “Hardware Options” on page 55
- “Recording the Serial Number and MAC Address” on page 58
- “Installing the Switch on a Table” on page 59

Reviewing Safety Precautions

Review the following safety precautions before beginning the installation procedure.

Note

Safety statements that have the  symbol are translated into multiple languages in the *Translated Safety Statements* document at www.alliedtelesis.com/en/documents/translated-safety-statements.

Note

Les consignes de sécurité portant le symbole  sont traduites dans plusieurs langues dans le document *Translated Safety Statements*, disponible à l'adresse www.alliedtelesis.com/en/documents/translated-safety-statements.



Warning

Class 1 Laser product.  L1



Warning

Do not stare into the laser beam.  L2



Warning

Do not look directly at the fiber optic cable ends or inspect the cable ends with an optical lens.  L6



Warning

To prevent electric shock, do not remove the cover. No user-serviceable parts inside. This unit contains hazardous voltages and should only be opened by a trained and qualified technician. To avoid the possibility of electric shock, disconnect electric power to the product before connecting or disconnecting the LAN cables.

 E1



Warning

Do not work on equipment or cables during periods of lightning activity.  E2



Warning

Power cord is used as a disconnection device. To de-energize equipment, disconnect the power cord. ⚡ E3



Warning

Class I Equipment. This equipment must be earthed. The power plug must be connected to a properly wired earth ground socket outlet. An improperly wired socket outlet could place hazardous voltages on accessible metal parts. ⚡ E4

Note

Pluggable Equipment. The socket outlet shall be installed near the equipment and shall be easily accessible. ⚡ E5



Caution

Air vents must not be blocked and must have free access to the room ambient air for cooling. ⚡ E6



Warning

Operating Temperatures. This product is designed for a maximum ambient temperature of 45 degrees C. ⚡ E57

Note

All Countries: Install product in accordance with local and National Electrical Codes. ⚡ E8



Warning

Only trained and qualified personnel are allowed to install or replace this equipment. ⚡ E14



Caution

Circuit Overloading: Consideration should be given to the connection of the equipment to the supply circuit and the effect that overloading of circuits might have on overcurrent protection and supply wiring. Appropriate consideration of equipment nameplate ratings should be used when addressing this concern. ⚡ E21



Caution

Risk of explosion if battery is replaced by an incorrect type. Replace only with the same or equivalent type recommended by the manufacturer. Dispose of used batteries according to the manufacturer's instructions. *↻* E22



Warning

Mounting of the equipment in the rack should be such that a hazardous condition is not created due to uneven mechanical loading. *↻* E25

Note

Use dedicated power circuits or power conditioners to supply reliable electrical power to the device. *↻* E27



Caution

The chassis may be heavy and awkward to lift. Allied Telesis recommends that you get assistance when mounting the chassis in an equipment rack. *↻* E28

Note

If installed in a closed or multi-unit rack assembly, the operating ambient temperature of the rack environment may be greater than the room ambient temperature. Therefore, consideration should be given to installing the equipment in an environment compatible with the manufacturer's maximum rated ambient temperature (T_{mra}).
↻ E35



Caution

Installation of the equipment in a rack should be such that the amount of air flow required for safe operation of the equipment is not compromised. *↻* E36



Warning

Reliable earthing of rack-mounted equipment should be maintained. Particular attention should be given to supply connections other than direct connections to the branch circuits (e.g., use of power strips).
↻ E37



Caution

The unit does not contain serviceable components. Please return damaged units for servicing. *↻* E42



Warning

The temperature of an active SFP transceiver may exceed 40° C (158° F). Exercise caution when handling with unprotected hands. *↻* E43



Caution

You have to reset the switch to disable the VCStack feature. Some network traffic may be lost if the device is already connected to a live network. *↻* E75



Warning

Switches should not be stacked on top of one another on a table or desktop because that could present a personal safety hazard if you need to move or replace switches. *↻* E76



Warning

A transceiver can be damaged by static electricity. Be sure to observe all standard electrostatic discharge (ESD) precautions, such as wearing an anti-static wrist strap, to avoid damaging the device. *↻* E77

Choosing a Site for the Switch

Site and enclosure requirements are described in the following sections:

- “Site Requirements,” next
- “Enclosure Requirements” on page 47

Site Requirements

Observe these site requirements when planning the installation.

- The GS970EMX/10, GS970EMX/20, and GS970EMX/28 Switches are fanless.
- The GS970EMX/52 Switch has a single internal fan on the rear panel. Airflow direction is front-to-back, with the fan drawing air out of the chassis.
- You should verify that the temperature range and ventilation at the installation site are suitable for the device, and that there is adequate air flow around the units for cooling. The operating temperature range of the switches is provided in “Environmental Specifications” on page 134.
- If you plan to install the switch in an equipment rack, verify that the rack is safely secured so that it will not tip over. Devices in a rack should be installed starting at the bottom, with the heavier devices near the bottom of the rack.
- If you plan to install the switch on a table, verify that the table is level and stable.
- The power outlet should be located near the switch and be easily accessible.
- The site should allow for easy access to the ports on the front of the switch, so that you can easily connect and disconnect cables, and view the port LEDs.
- Do not install the switch in a wiring or utility box without adequate airflow. The switch might overheat and fail. Refer to “Enclosure Requirements” on page 47.
- The site should not expose the switch to moisture or water.
- The site should be a dust-free environment.
- The site should include dedicated power circuits or power conditioners to supply reliable electrical power to the network devices.
- The site should not expose the copper cabling to sources of electrical noise, such as radio transmitters, broadband amplifiers, power lines, electric motors, and fluorescent fixtures.
- Switch ports are suitable for intra-building connections, or where non-exposed cabling is required.

- ❑ Do not place objects on top of the switch.



Warning

Switches should not be stacked on top of one another on a table or desktop because that could present a personal safety hazard if you need to move or replace switches. ⚡ E76

Enclosure Requirements

Observe these guidelines when installing the switch in an enclosure:

- ❑ Verify that the enclosure has adequate airflow so that unit does not overheat.
- ❑ Select an enclosure that is large enough for the switch and all other included equipment.
- ❑ The enclosure size must be determined by considering multiple factors, including the outside ambient temperature, total heat generated by the installed equipment, sealed or unsealed enclosure type, enclosure material, paint color, mounting method (wall, pole, ground, etc.), and sun exposure. The smaller enclosure size you choose, the higher the risk of overheating the product faces.

Note

If the product overheats in an enclosure that was selected without taking into account these factors, the warranty of the product might be voided. Consult Allied Telesis when assistance is needed.

- ❑ The enclosure's BTU/hour rating must be higher than the total BTU/hour values of installed equipment, over the expected operating temperature range. For the operating temperature ratings, refer to Table 10, "Environmental Specifications" on page 134.
- ❑ Be sure to review the enclosure's installation guide for rules and restrictions on site requirements, and to follow all guidelines and safety warnings.

Unpacking the Switch

The GS970EMX/10 and GS970EMX/20 Switches come with the accessory items in Figure 12.

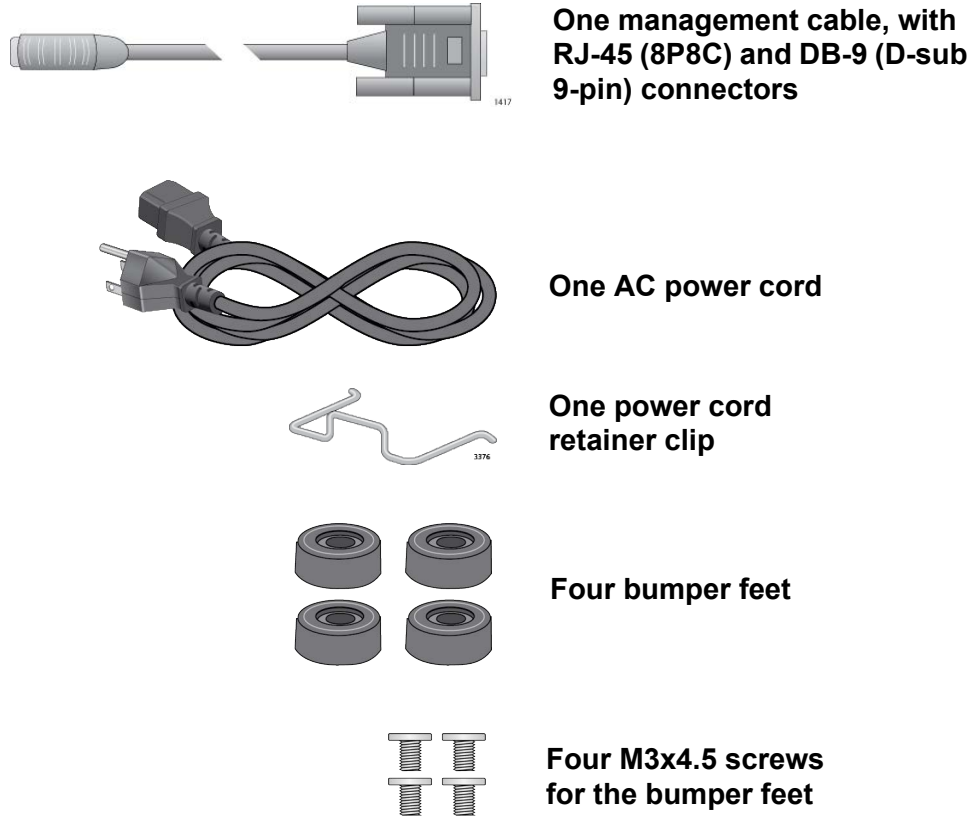

Figure 12. Accessory Items Included with the GS970EMX/10 and GS970EMX/20 Switches

Note

Please retain the original packaging material in the event you need to return the unit to Allied Telesis.

The GS970EMX/28 Switch comes with the accessory items in Figure 13.



One management cable, with RJ-45 (8P8C) and DB-9 (D-sub 9-pin) connectors

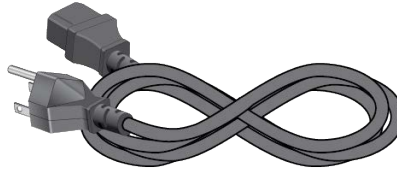

One AC power cord



One power cord retainer clip

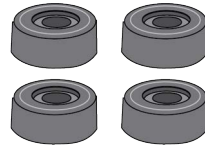

Four bumper feet

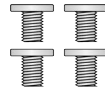

Four M3x4.5 screws for the bumper feet

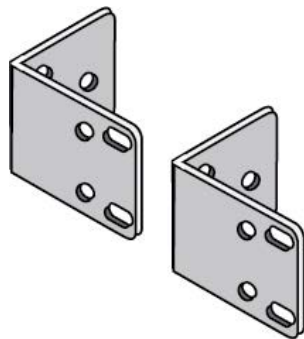

Two equipment rack brackets



Six 4x8mm screws for attaching the brackets to the switch

Figure 13. Accessory Items Included with the GS970EMX/28 Switch

The GS970EMX/52 Switch comes with the accessory items in Figure 14.



One management cable, with RJ-45 (8P8C) and DB-9 (D-sub 9-pin) connectors

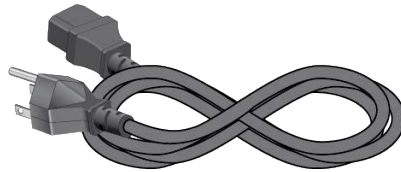

One AC power cord



One power cord retainer clip



Four bumper feet with rivets

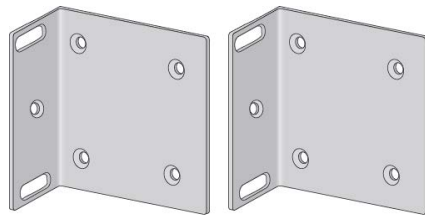

Two wall/equipment rack brackets



Eight 3x6mm Phillips-head screws for attaching the brackets to the switch

Figure 14. Accessory Items Included with the GS970EMX/52 Switch

Note

If any item is missing or damaged, contact your Allied Telesis sales representative for assistance.

Installation Options

The following sections illustrate the installation options for the switches.

GS970EMX/10 Switch

Figure 15 illustrates the installation options for the GS970EMX/10 Switch.



Table or desktop with the bumper feet included with the switch.



Standard 19-inch equipment rack with the RKMT-J05 rack-mount brackets kit. Kit sold separately.

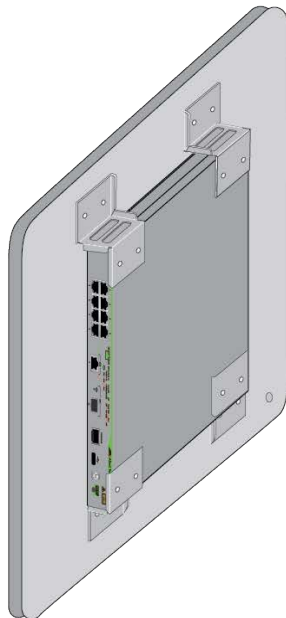

Wall installation with the BRKT-J23 brackets kit. Kit sold separately.

Figure 15. Installation Options for the GS970EMX/10 Switch

GS970EMX/20 Switch

Figure 16 illustrates the installation options for the GS970EMX/20 Switch.

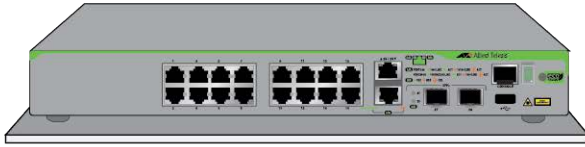
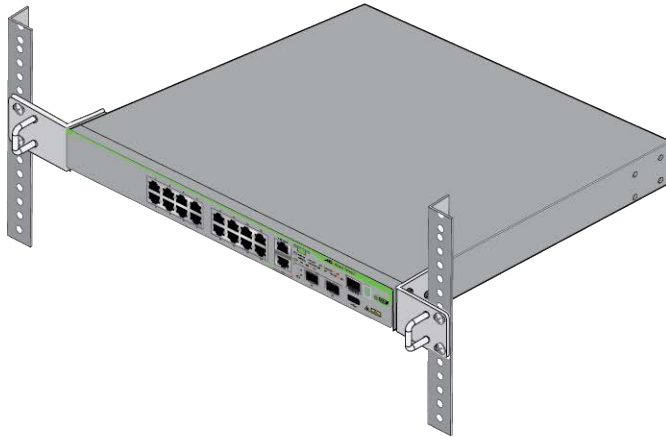
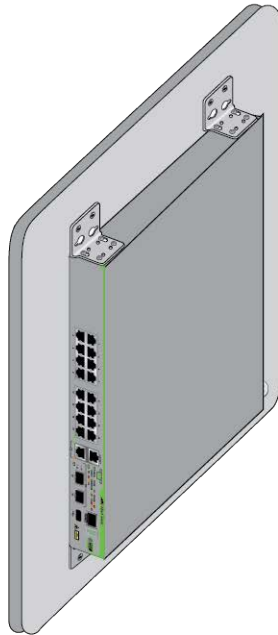

Table or desktop with the bumper feet included with the switch.



Standard 19-inch equipment rack with the RKMT-J13 equipment rack brackets kit. Kit sold separately.



Wall installation with the BRKT-J24 wall brackets kit. Kit sold separately.

Figure 16. Installation Options for the GS970EMX/20 Switch

GS970EMX/28 Switch

Figure 17 illustrates the installation options for the GS970EMX/28 Switch.

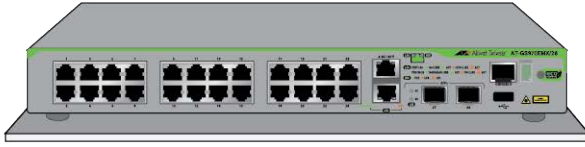
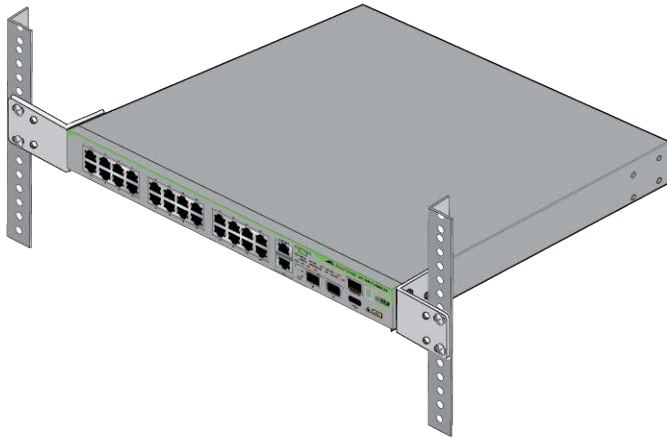
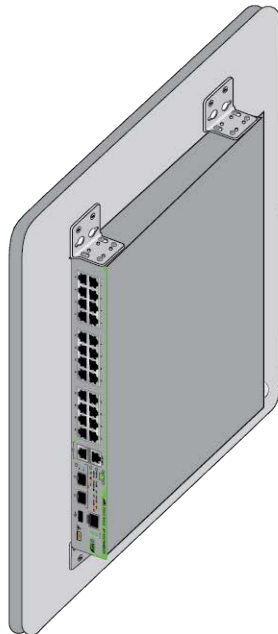

Table or desktop with the bumper feet included with the switch.



Standard 19-inch equipment rack with the equipment rack brackets included with the switch, or the RKMT-J13 equipment rack brackets kit. Kit sold separately.



Wall installation with the BRKT-J24 wall brackets kit. Kit sold separately.

Figure 17. Installation Options for the GS970EMX/28 Switch

GS970EMX/52 Switch

Figure 18 illustrates the installation options for the GS970EMX/52 Switch.

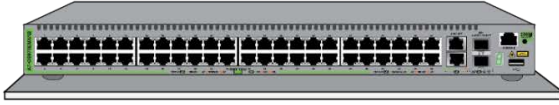
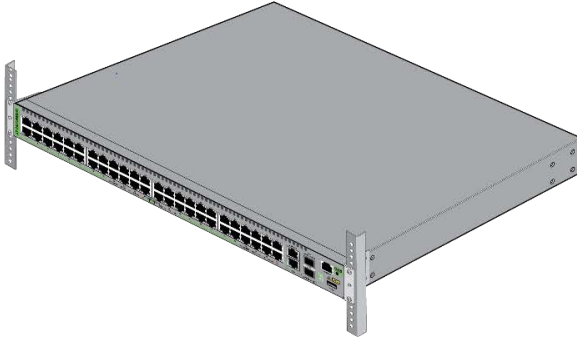
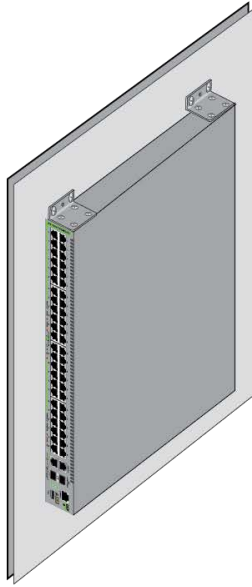

Table or desktop with the bumper feet included with the switch.



Standard 19-inch equipment rack with the wall/equipment rack brackets included with the switch.



Wall installation with the wall/equipment rack brackets included with the switch.

Figure 18. Installation Options for the GS970EMX/52 Switch

Hardware Options

The following hardware options are sold separately.

Note

The GS970EMX/52 Switch does not require the hardware options.

RKMT-J05 Equipment Rack Brackets Kit

Installing the GS970EMX/10 Switch in a standard 19-inch equipment rack requires the RKMT-J05 brackets kit. Refer to Figure 19. For instructions, refer to Chapter 3, “Installing the GS970EMX/10 Switch in an Equipment Rack” on page 63.

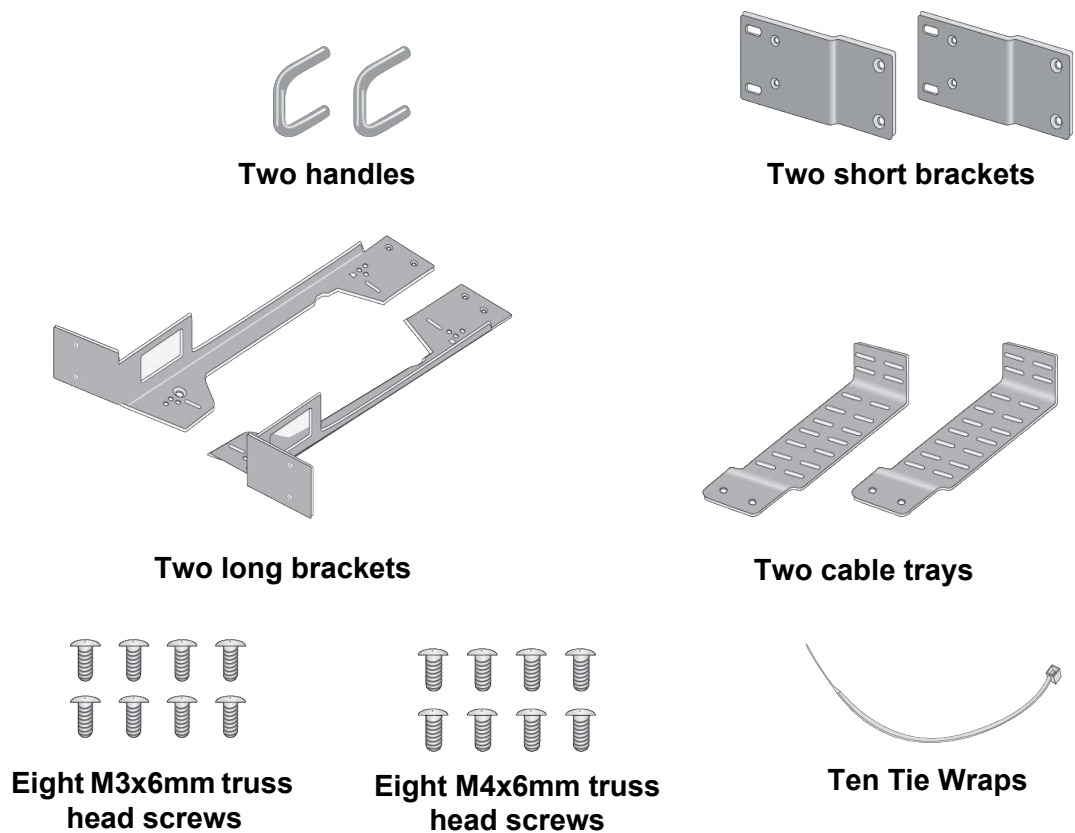

Figure 19. RKMT-J05 Equipment Rack Brackets Kit for the GS970EMX/10 Switch

BRKT-J23 Wall Brackets Kit

The GS970EMX/10 Switch is installed on a wall with the BRKT-J23 wall brackets kit. Refer to Figure 20. For instructions, refer to Chapter 7, “Installing the GS970EMX/10 Switch on a Wall” on page 85.

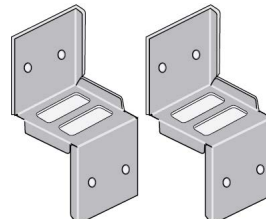
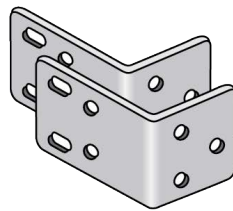

Figure 20. BRKT-J23 Wall Brackets Kit for the GS970EMX/10 Switch

RKMT-J13 Equipment Rack Brackets Kit

Installing the GS970EMX/20 Switch in a standard 19-inch equipment rack requires the RKMT-J13 brackets kit. Refer to Figure 21. The kit allows you to install the switch with the front panel flush with or recessed 50mm (2 in.) behind the front of the equipment rack. For instructions, refer to Chapter 4, “Installing the GS970EMX/20 Switch in an Equipment Rack” on page 71.



Two equipment rack brackets

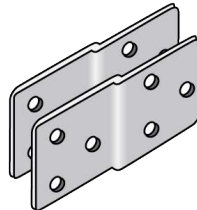

Two bracket extenders



Two handles



Four 3x6mm screws for attaching the handles to the brackets



Twelve 4x8mm screws for attaching the brackets to the switch

Figure 21. RKMT-J13 Equipment Rack Brackets Kit for the GS970EMX/20 Switch

Note

The GS970EMX/28 and GS970EMX/52 Switches come with brackets for equipment rack installations.

BRKT-J24 Wall Brackets Kit

The GS970EMX/20 and GS970EMX/28 Switches are installed on a wall with the BRKT-J24 wall brackets kit. Refer to Figure 22. For instructions, refer to Chapter 8, “Installing GS970EMX/20, GS970EMX/28, and GS970EMX/52 Switches on a Wall” on page 95.

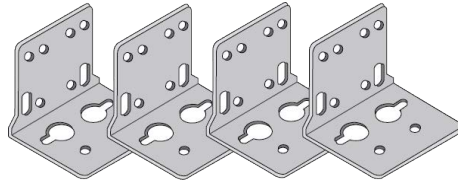

Four BRKT-J24 wall brackets



Sixteen 4x6mm screws

Figure 22. BRKT-J24 Wall Brackets Kit for the GS970EMX/20 and GS970EMX/28 Switches

Note

The GS970EMX/52 Switch comes with brackets for installing the device on a wall.

Recording the Serial Number and MAC Address

The serial number and MAC address of the switch are located on labels on the bottom panel. Refer to Figure 23. If you need to record the numbers for your records, you should do so before installing the device.



Figure 23. Serial Number and MAC Address Labels

Note

You can also view the serial number and MAC address of the switch with the `SHOW SYSTEM SERIALNUMBER` and `SHOW SYSTEM MAC` commands in the User Exec and Privileged EXEC modes of the AlliedWare Plus management software.

Installing the Switch on a Table

You can operate the switches on a table or desktop. Refer to Figure 24.

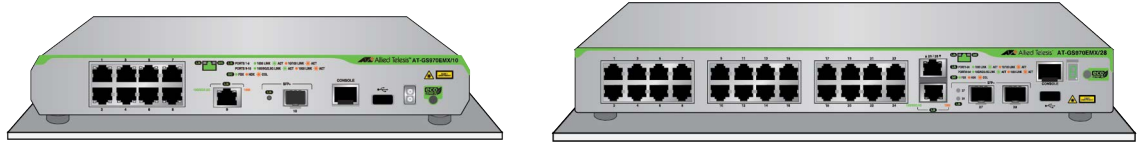

Figure 24. Switch Installation on a Table

The following guidelines are in addition to those in “Choosing a Site for the Switch” on page 46:

- Do not stack switches on a table.
- Do not install the switch upside down on a table.
- Do not install the switch vertically on a table.

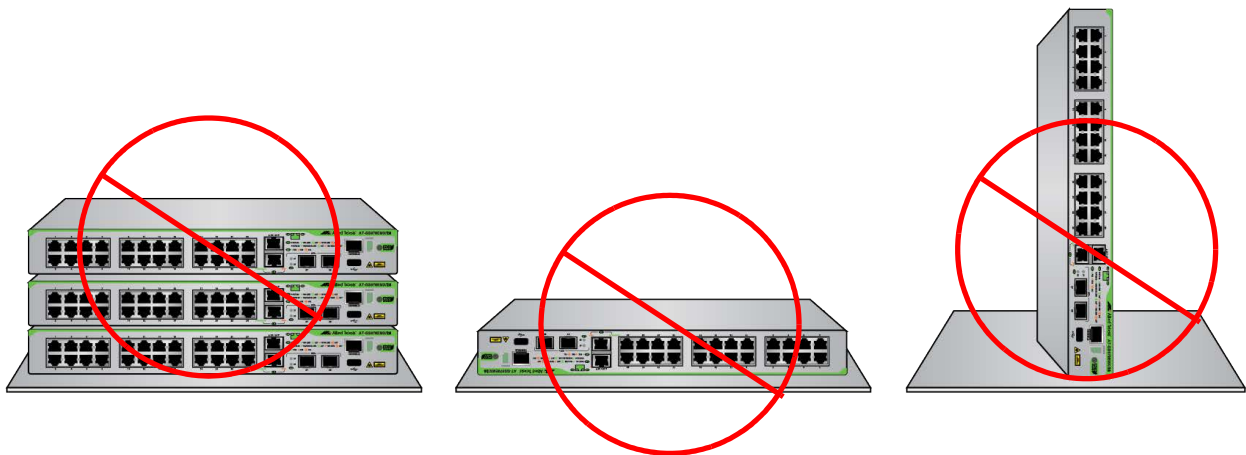

Figure 25. Unsupported Table Installations



Warning

Switches should not be stacked on a table or desktop. They could present a physical safety hazard should you move or replace switches. ⚡ E91



Warning

The device is heavy. Use both hands to lift it. You might injure yourself or damage the device if you drop it. ⚡ E94

Note

Bumper feet are required for tabletop installation. They promote cooling by allowing airflow beneath the switch.

To install the switch on a table, perform the following procedure:

1. Verify that the selected site is suitable for the unit by reviewing “Reviewing Safety Precautions” on page 42 and “Choosing a Site for the Switch” on page 46.
2. Verify that the table is strong enough to support the weight of the switch.
3. Verify that the accessory kit came with all the appropriate items. Refer to “Unpacking the Switch” on page 48.
4. Lift the switch from the shipping box and place it upside down on the table.
5. For the GS970EMX/10, GS970EMX/20, and GS970EMX/28 Switches, attach the four bumper feet to the bottom corners of the switch using the four 3x4.5mm screws and a Phillips-head screwdriver. Refer to Figure 26.

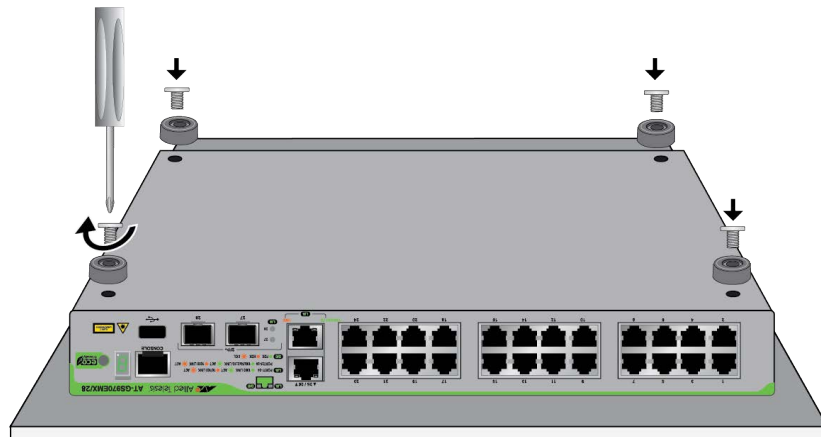

Figure 26. Attaching the Bumper Feet on GS970EMX/10, GS970EMX/20, and GS970EMX/28 Switches

6. For the GS970EMX/52 Switch, do the following:
 - a. Place a bumper foot over one of the corner holes on the bottom panel of the switch.

- b. Insert a rivet to secure the bumper foot. Refer to Figure 27.

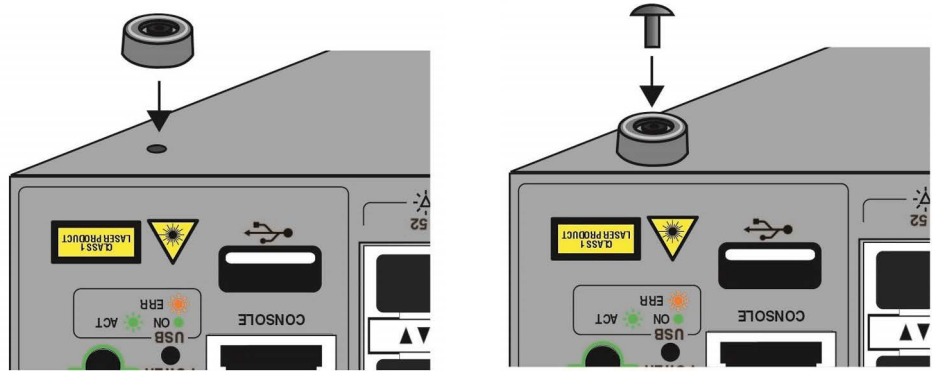

Figure 27. Attaching Bumper Feet on the GS970EMX/52 Switch

- c. Repeat this step to install the remaining bumper feet.
7. Turn the switch over, placing it on the bumper feet.
8. Go to Chapter 9, “Verifying the Switch” on page 105.

Chapter 3

Installing the GS970EMX/10 Switch in an Equipment Rack

The instructions in this chapter explain how to install the GS970EMX/10 Switch in a standard 19-inch equipment rack with the RKMT-J05 equipment rack brackets kit. Here are the sections:

- ❑ “Introduction” on page 64
- ❑ “Installing the GS970EMX/10 Switch” on page 66

Introduction

Installing the GS970EMX/10 Switch in a standard 19-inch equipment rack requires the RKMT-J05 equipment rack brackets kit. The brackets allow you to install the switch with the front panel flush with the front of the equipment rack or with the switch projecting in front of the rack. Refer to Figure 28. The kit is sold separately.



Figure 28. GS970EMX/10 Switch in an Equipment Rack with the RKMT-J05 Brackets Kit

The RKMT-J05 bracket kit includes two cable trays and ten tie wraps for physically securing the power cord or network cables. Refer to Figure 29.

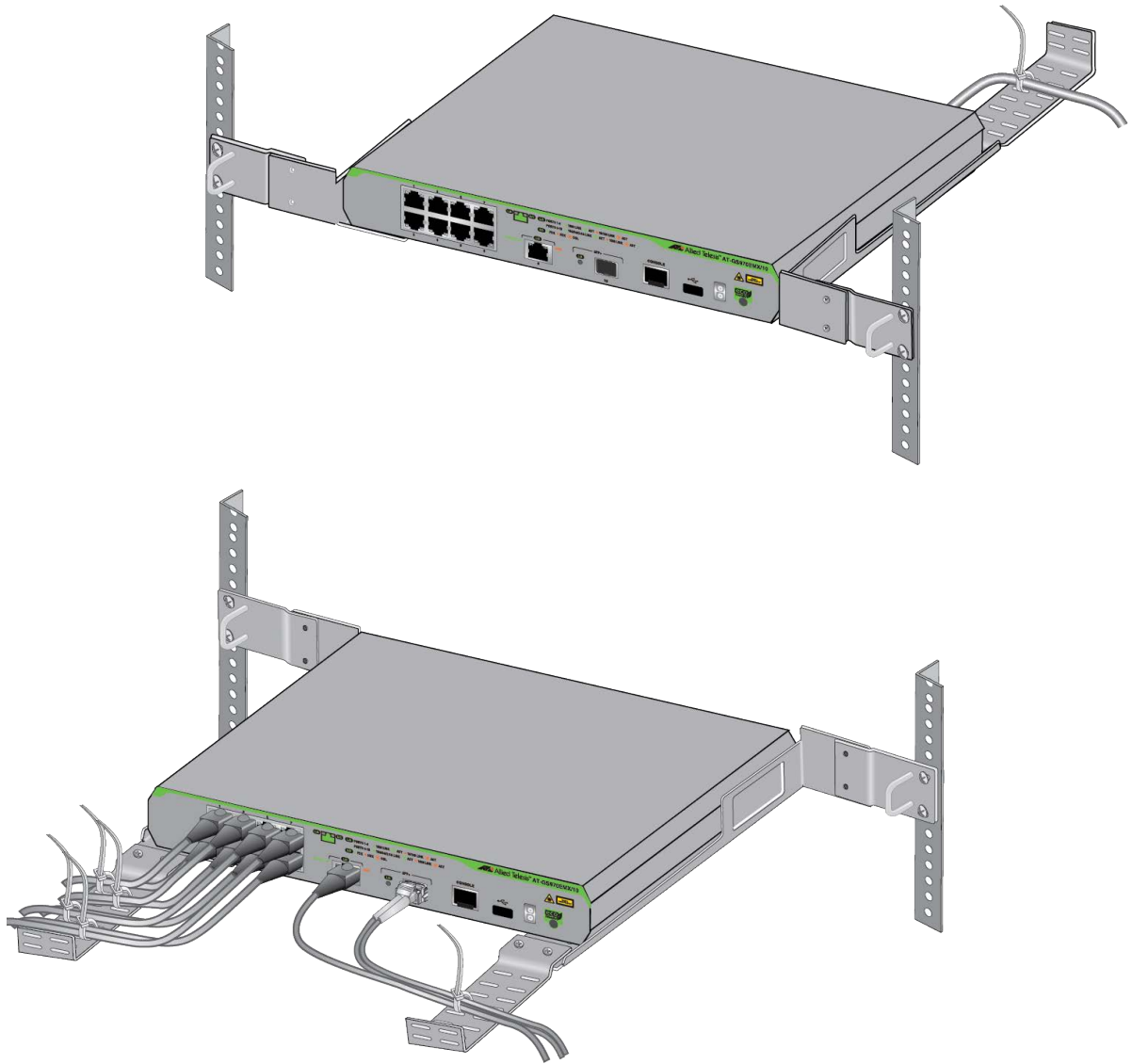

Figure 29. GS970EMX/10 Switch with RKMT-J05 Cable Trays

Installing the GS970EMX/10 Switch

This section contains instructions for installing the GS970EMX/10 Switch in a standard 19-inch equipment rack with the RKMT-J05 equipment rack brackets kit. Here are the required items:

- ❑ One RKMT-J05 rack mount brackets kit (sold separately)
- ❑ Phillips-head screwdriver (not provided)
- ❑ Four standard equipment rack screws (not provided)

To install the switch in a 19-inch equipment rack with the RKMT-J05 equipment rack brackets kit, perform the following procedure:

1. Place the switch on a table.

Note

If the bumper feet are attached to the bottom on the switch, remove them before continuing.

2. Unpack the RKMT-J05 equipment rack brackets kit and verify the contents. Refer to Figure 19 on page 55.
3. Attach the handles in the RKMT-J05 kit to the short brackets using the supplied M3x6mm pan head screws and a Phillips-head screwdriver. Be sure to attach the handles to the correct sides of the short brackets for your switch-brackets configuration. Refer to Figure 30. The handles are optional.

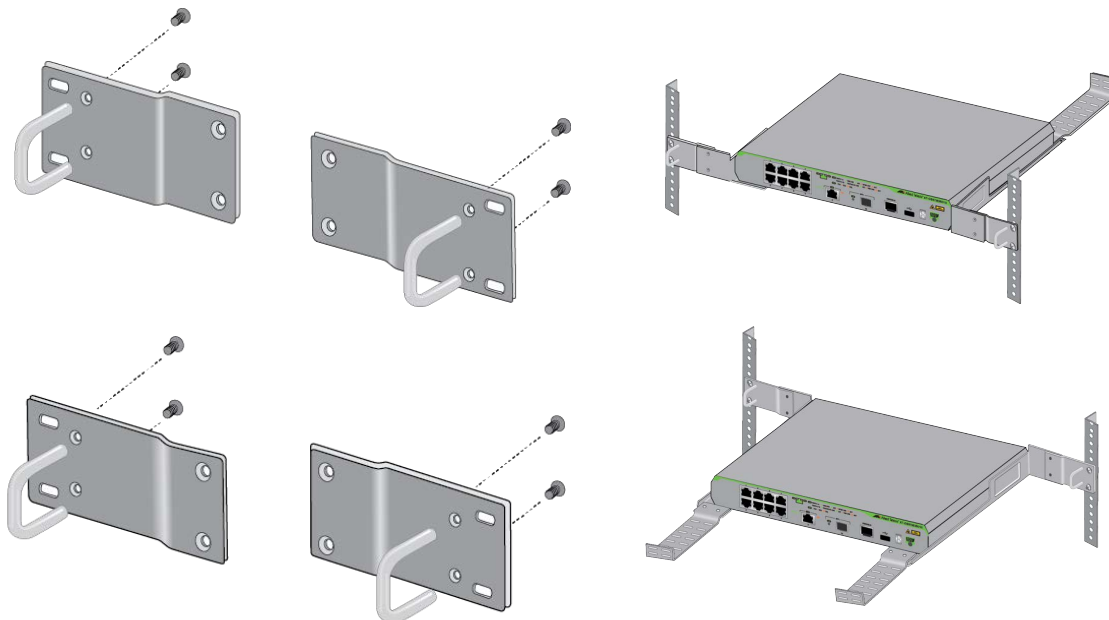

Figure 30. Attaching the RKMT-J05 Handles to the Short Brackets

4. Attach the short brackets to the long brackets using the supplied M4x6mm countersunk screws. Refer to Figure 31.

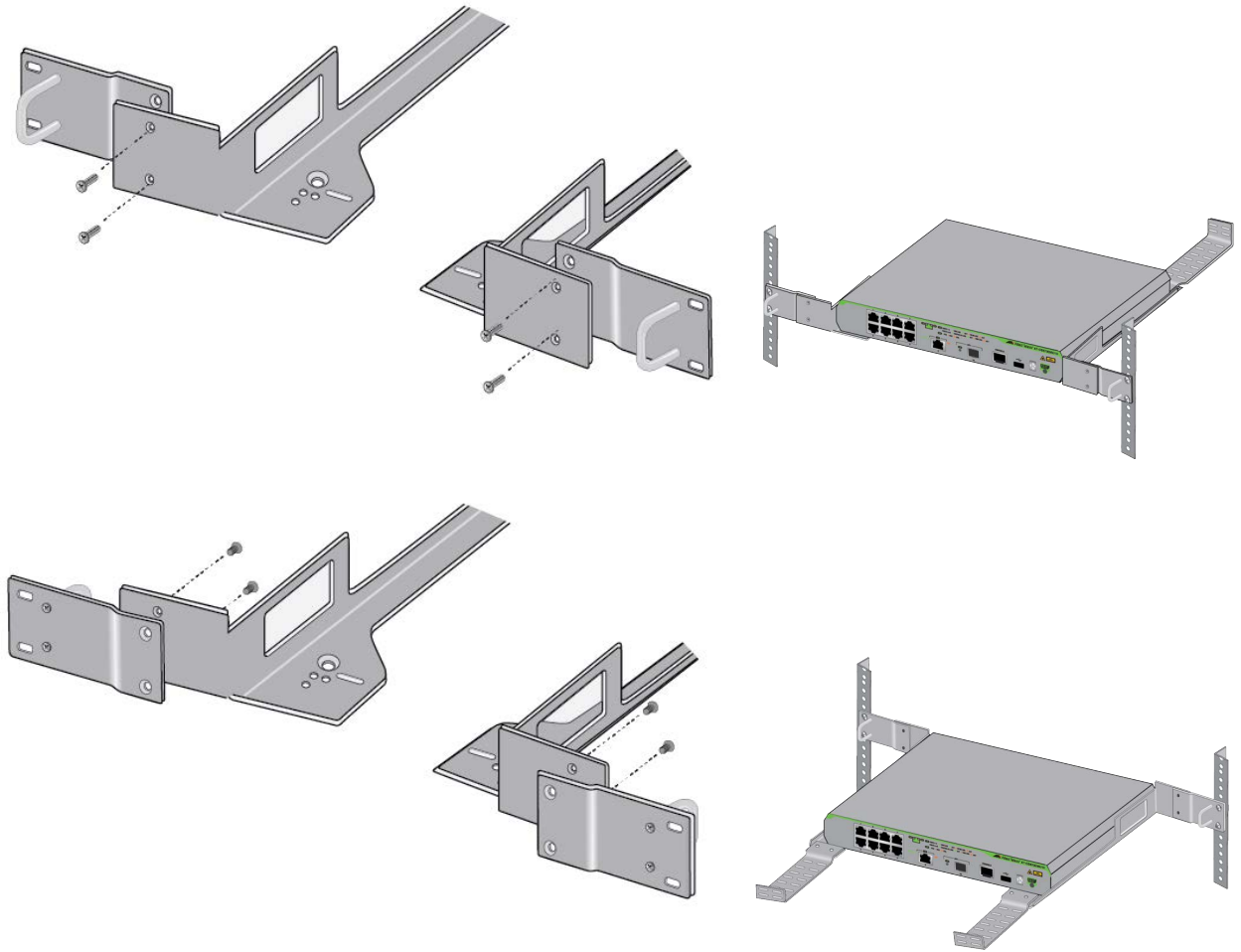

Figure 31. Attaching the Short RKMT-J05 Brackets to the Long Brackets

5. Attach one or both cord trays to the long brackets. The cord trays are optional. Refer to Figure 32.

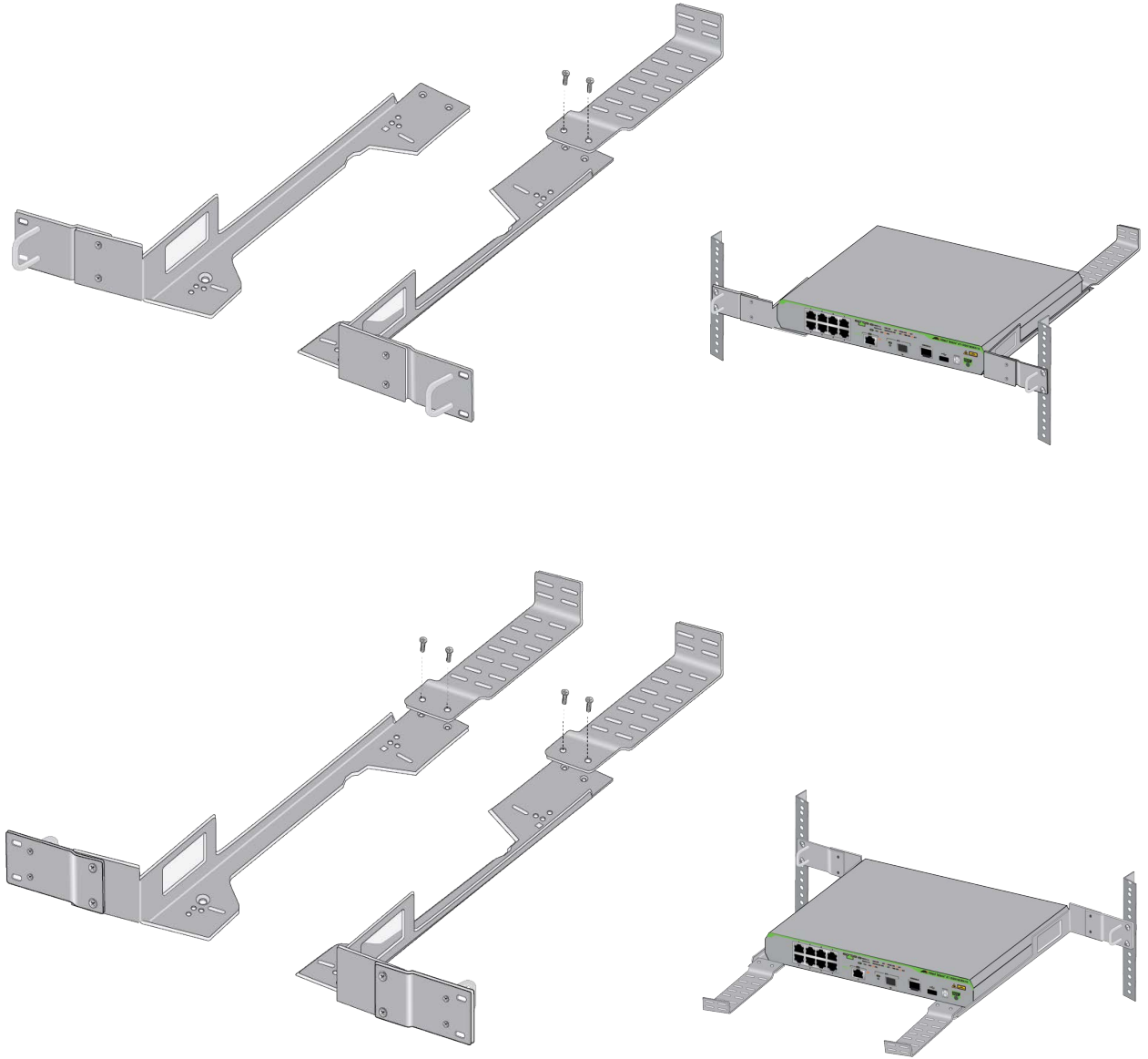

Figure 32. Attaching the RKMT-J05 Cord Trays to the Long Brackets

6. Attach the brackets to the bottom panel of the switch. Refer to Figure 33.

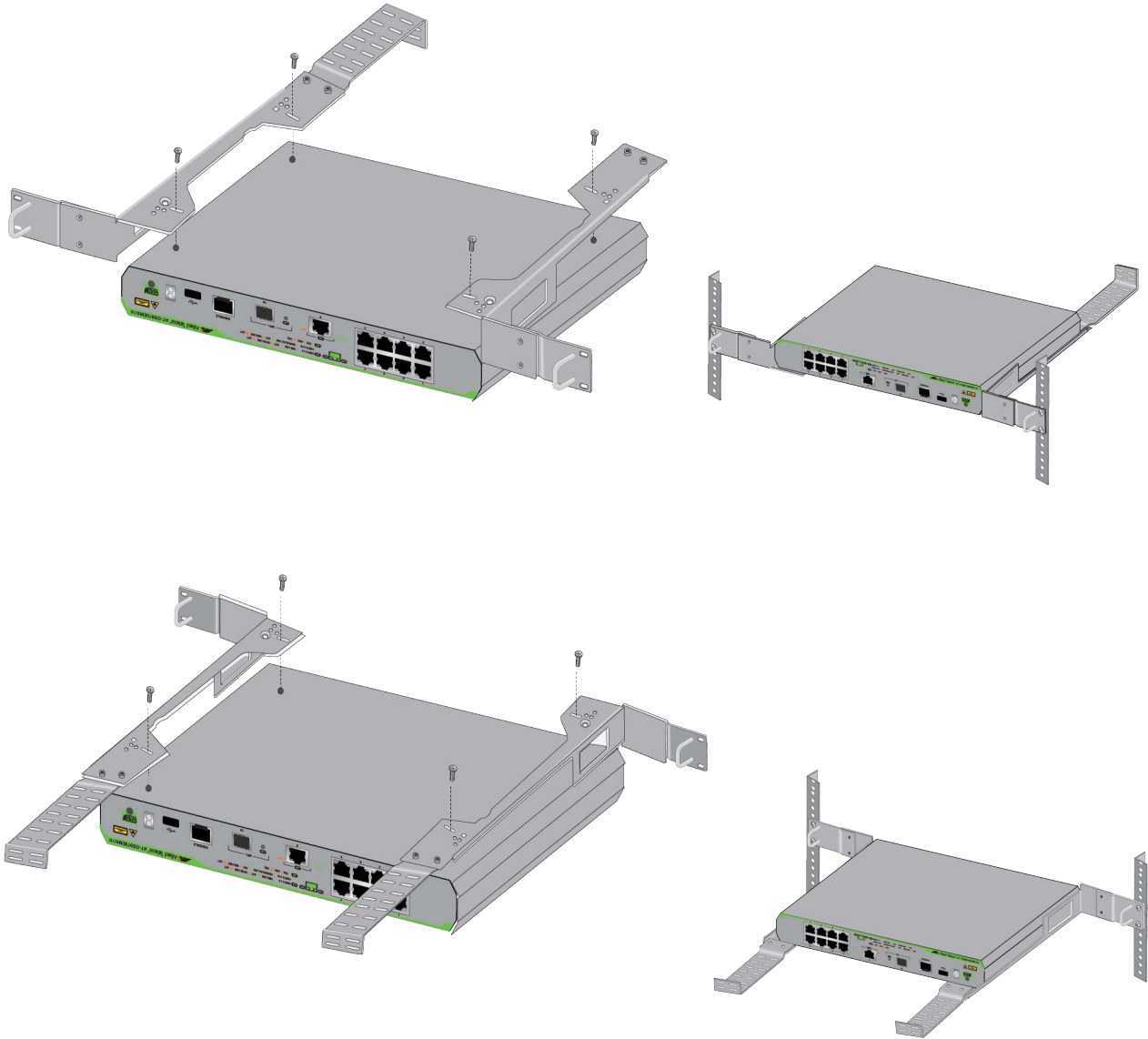

Figure 33. Attaching the RKMT-J05 Brackets to the Switch

7. Turn the switch right-side up on the table.

8. Have another person hold the switch in the equipment rack while you secure it with four standard equipment rack screws (not provided). Refer to Figure 34.

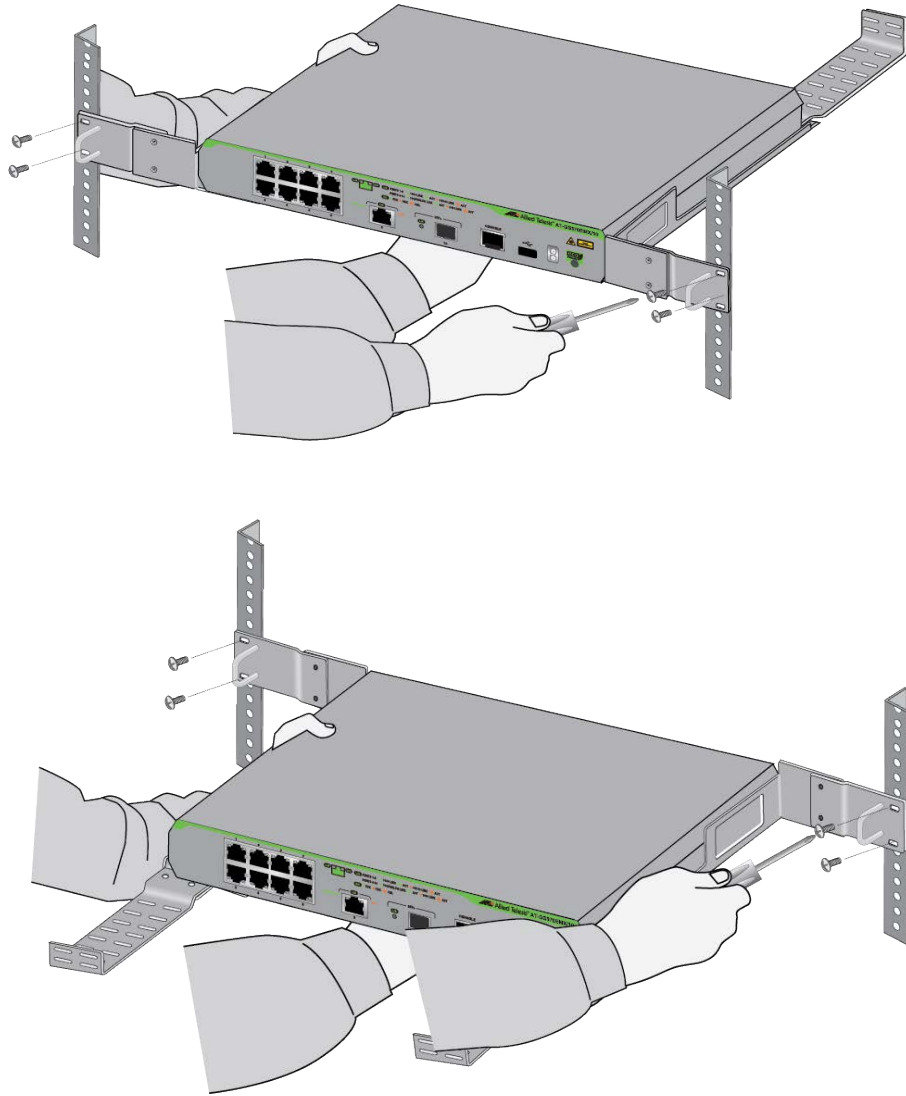

Figure 34. Attaching the GS970EMX/10 Switch to an Equipment Rack

9. Go to Chapter 9, “Verifying the Switch” on page 105.

Chapter 4

Installing the GS970EMX/20 Switch in an Equipment Rack

This chapter contains installation instructions for the GS970EMX/20 Switch in a standard 19-inch equipment rack with the RKMT-J13 equipment rack brackets kit. Here are the sections in the chapter:

- ❑ “Introduction” on page 72
- ❑ “Installing the GS970EMX/20 Switch” on page 73

Introduction

Installing the GS970EMX/20 Switch in a standard 19-inch equipment rack requires the RKMT-J13 equipment rack brackets kit. The kit allows you to install the switch with its front panel flush with or recessed 50mm (2 in.) behind the front of the equipment rack. Refer to Figure 35. The kit is sold separately.

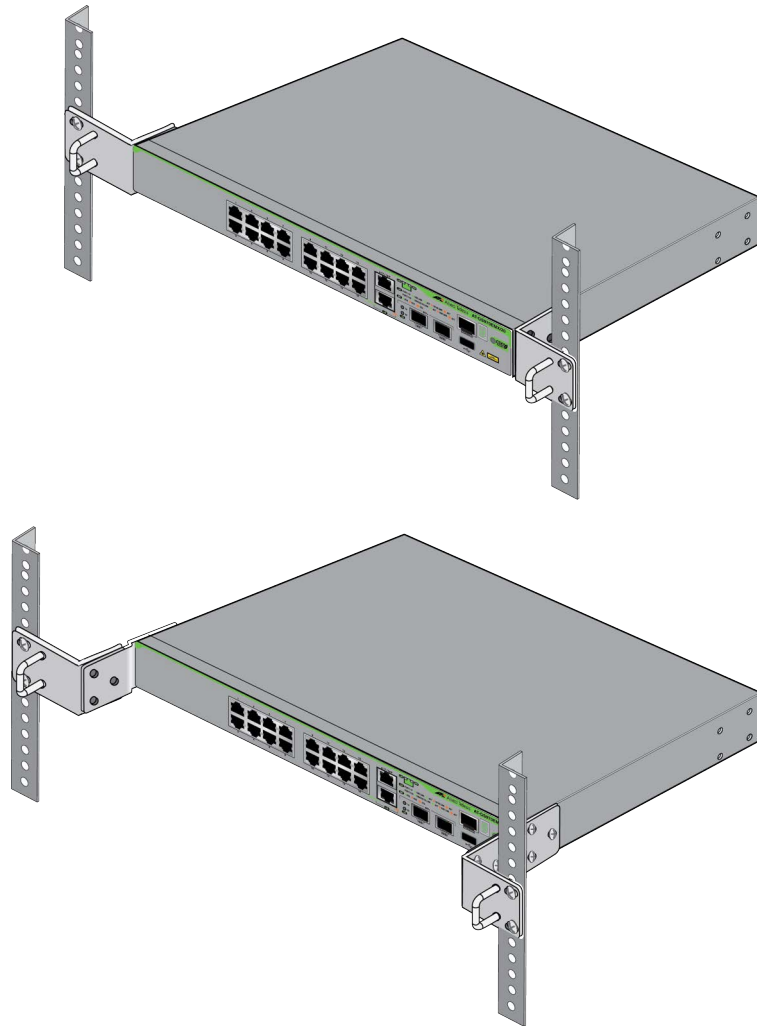

Figure 35. GS970EMX/20 Switch with RKMT-J13 Equipment Rack Brackets Kit

Note

The GS970EMX/28 Switch comes with two equipment rack brackets. You can install the switch in an equipment rack with the two brackets included with the unit, or the RKMT-J13 kit.

Installing the GS970EMX/20 Switch

This section contains the procedure for installing the GS970EMX/20 Switch in standard 19-inch equipment rack with the RKMT-J13 equipment rack brackets kit. Here are the required items:

- ❑ One RKMT-J13 equipment rack brackets kit.
- ❑ Cross-head screwdriver (not provided).
- ❑ Flat-head screwdriver (not provided).
- ❑ Four standard equipment rack screws (not provided).

To install the GS970EMX/20 Switch in a 19-inch equipment rack, perform the following procedure:

1. Place the switch on a table.

Note

If the bumper feet are attached to the bottom on the switch, remove them before continuing.

2. Unpack the RKMT-J13 equipment rack brackets kit and verify the contents. Refer to Figure 21 on page 56.
3. Attach the handles to the RKMT-J13 brackets with the four 3x6mm screws included in the kit. The handles are optional. Refer to Figure 36.

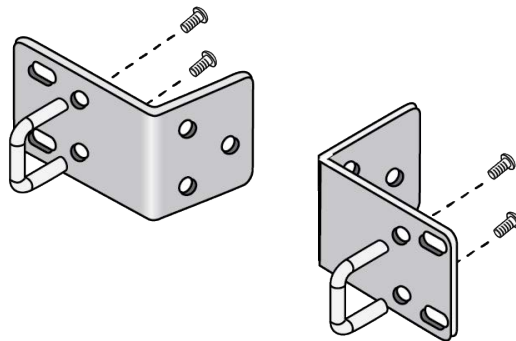

Figure 36. Attaching the Handles to the RKMT-J13 Brackets

4. If you want to recess the front of the switch in the equipment rack 50mm (2 in.), attach the extenders to the brackets with six of the 4x8mm screws included in the kit. Refer to Figure 37 on page 74.

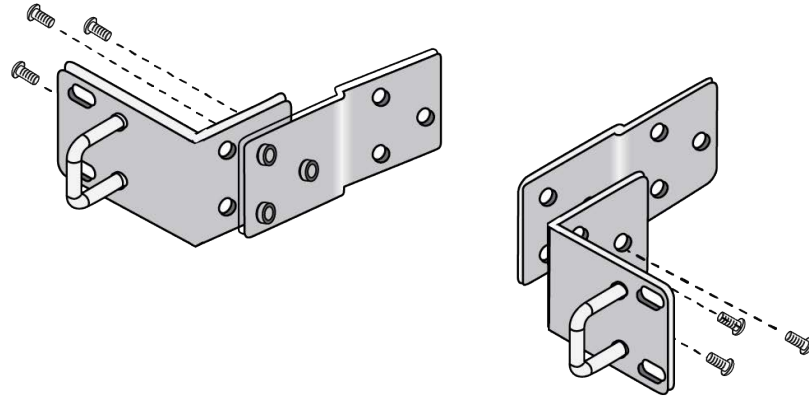

Figure 37. Attaching the Extenders to the RKMT-J13 Brackets

5. Attach the brackets to the sides of the switch with six of the 4x8mm screws included in the kit. Refer to Figure 38.

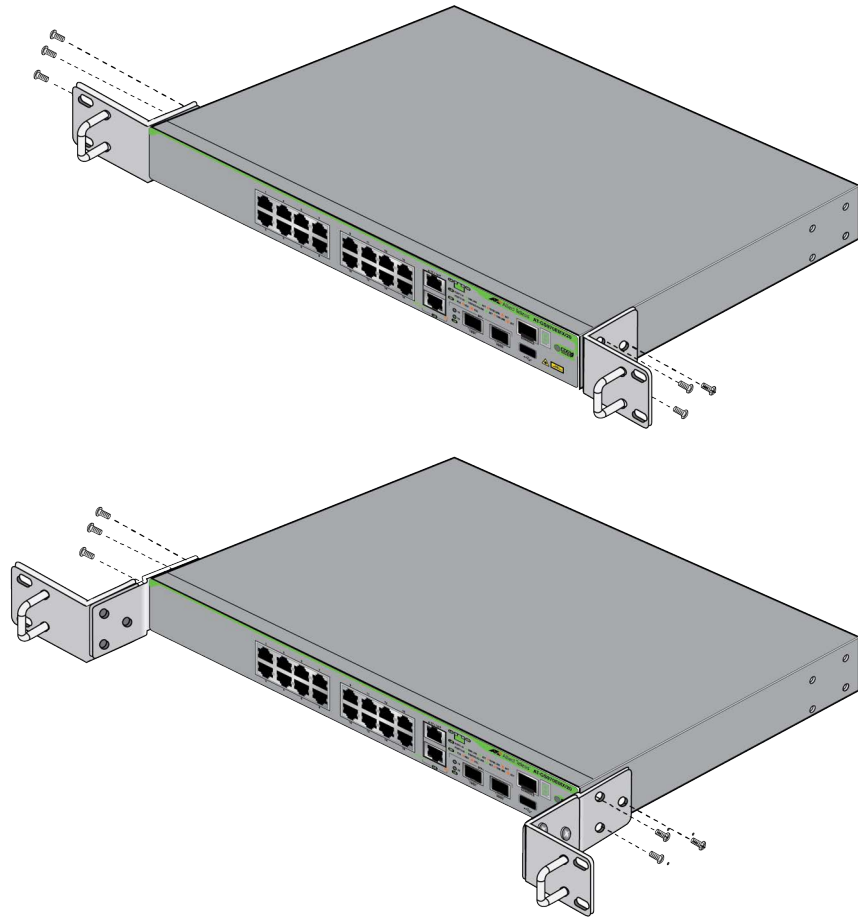

Figure 38. Attaching the RKMT-J13 Brackets to the GS970EMX/20 Switch

6. Have another person hold the switch at the selected location in the equipment rack while you secure it using four standard equipment rack screws (not provided). Refer to Figure 39.

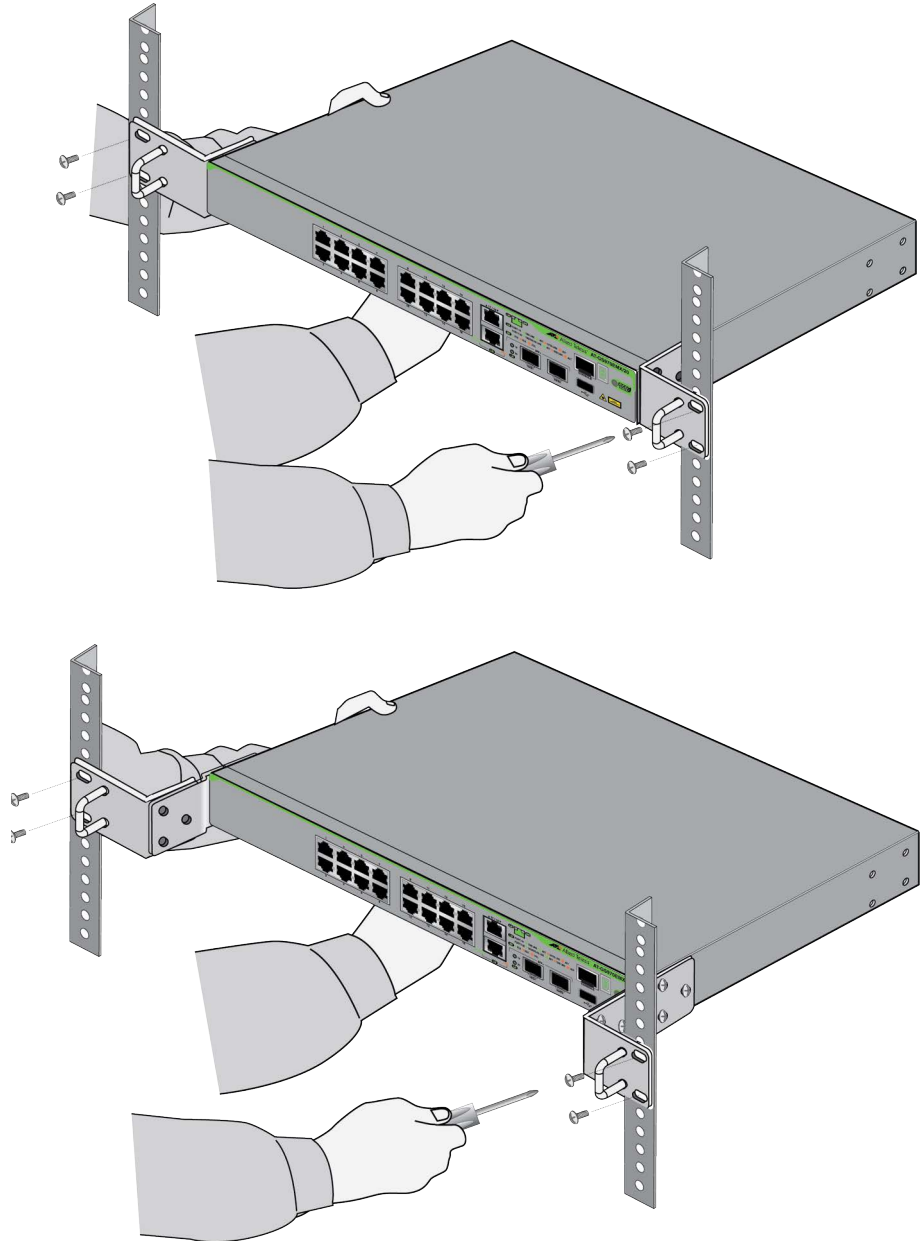

Figure 39. Securing the GS970EMX/20 Switch in a Standard 19-inch Equipment Rack

7. Go to Chapter 9, “Verifying the Switch” on page 105.

Chapter 5

Installing the GS970EMX/28 Switch in an Equipment Rack

This chapter contains installation instructions for the GS970EMX/28 Switch in a standard 19-inch equipment rack. Here are the sections:

- “Introduction” on page 78
- “Installing the GS970EMX/28 Switch” on page 79

Introduction

The GS970EMX/28 Switch comes with two brackets for installing the device in a standard 19-inch equipment rack. Refer to Figure 40. The brackets and screws are shown in Figure 13 on page 49.

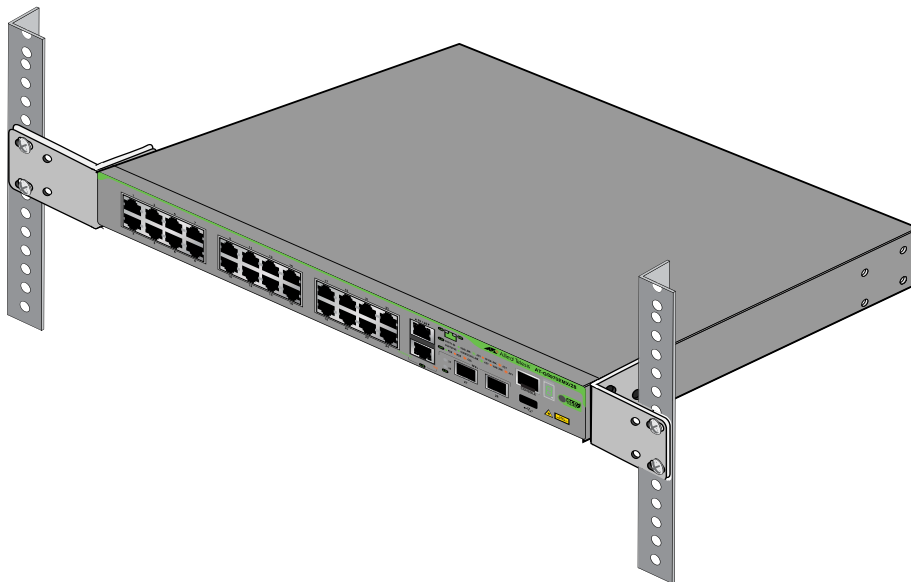

Figure 40. GS970EMX/28 Switch Installed in a Standard 19-inch Equipment Rack

Note

You can install the GS970EMX/28 Switch in an equipment rack with the brackets that come with the device or with the RKMT-J13 equipment rack brackets kit, which is sold separately.

Installing the GS970EMX/28 Switch

This section contains the procedure for installing the GS970EMX/28 Switch in a standard 19-inch equipment rack with the two equipment rack brackets included with the device. Here are the required items:

- ❑ Two equipment rack brackets (included with the switch).
- ❑ Six M4x8mm bracket screws (included with the switch).
- ❑ Cross-head screwdriver (not provided).
- ❑ Four standard equipment rack screws (not provided).

To install the GS970EMX/28 Switch in a 19-inch equipment rack, perform the following procedure:

1. Place the switch on a table.

Note

If the bumper feet are attached to the bottom on the switch, remove them before continuing.

2. Attach the equipment rack brackets to the sides of the switch with the six 4x8mm screws included with the device. The brackets can be installed on the switch only one way. Refer to Figure 41.

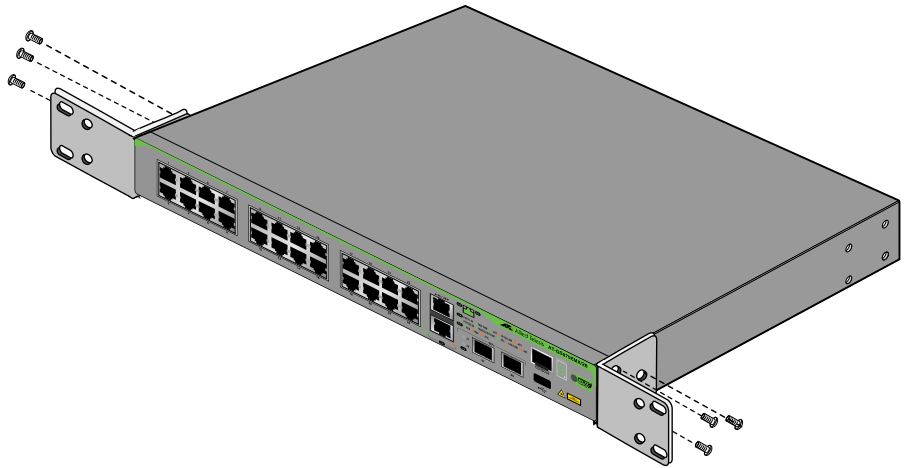

Figure 41. Attaching the Equipment Rack Brackets to the GS970EMX/28 Switch

3. Have another person hold the switch at the selected location in the equipment rack while you secure it using four standard equipment rack screws (not provided). Refer to Figure 42 on page 80.

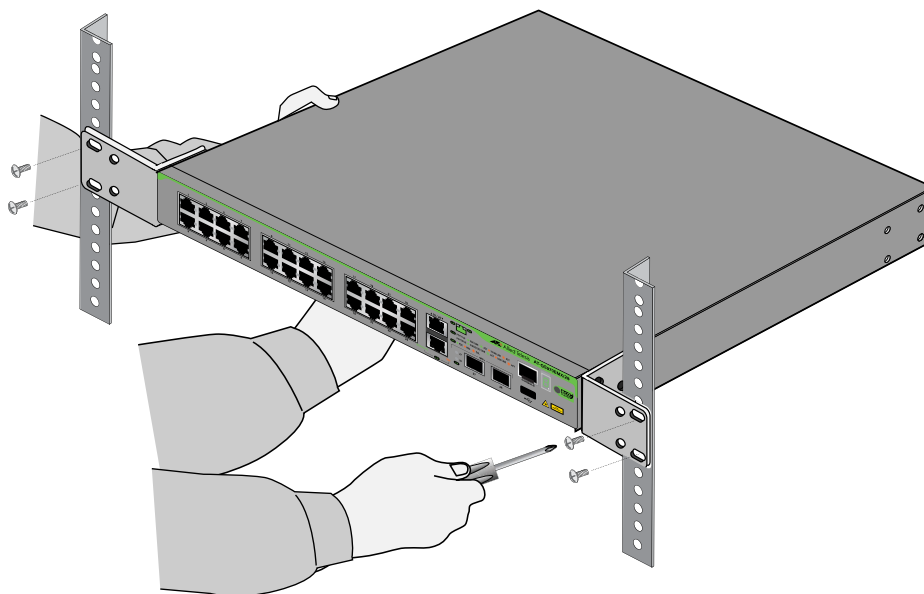

Figure 42. Securing the GS970EMX/28 Switch in a Standard 19-inch Equipment Rack

4. Go to Chapter 9, “Verifying the Switch” on page 105.

Chapter 6

Installing the GS970EMX/52 Switch in an Equipment Rack

This chapter contains the installation instructions for the GS970EMX/52 Switch in a standard 19-inch equipment rack. Here are the sections:

- “Introduction” on page 82
- “Installing the GS970EMX/52 Switch” on page 83

Introduction

The GS970EMX/52 Switch comes with two brackets and eight screws for installing the device in a standard 19-inch equipment rack. Refer to Figure 14 on page 50.

The switch has two sets of four screw holes on the left and right sides for the brackets. Refer to Figure 43.

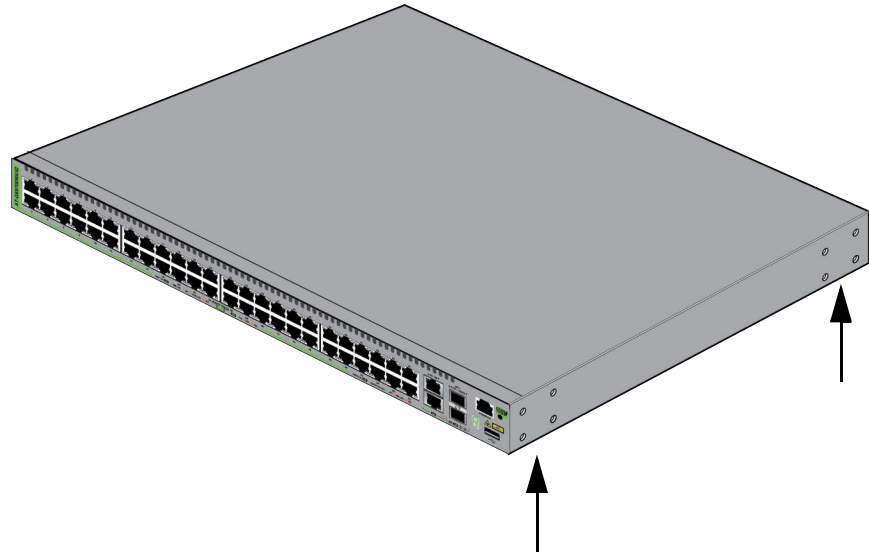

Figure 43. Bracket Screw Holes on the GS970EMX/52 Switch

You can install the brackets so that the front of the switch is flush with or extending in front of the equipment rack. Refer to Figure 44.

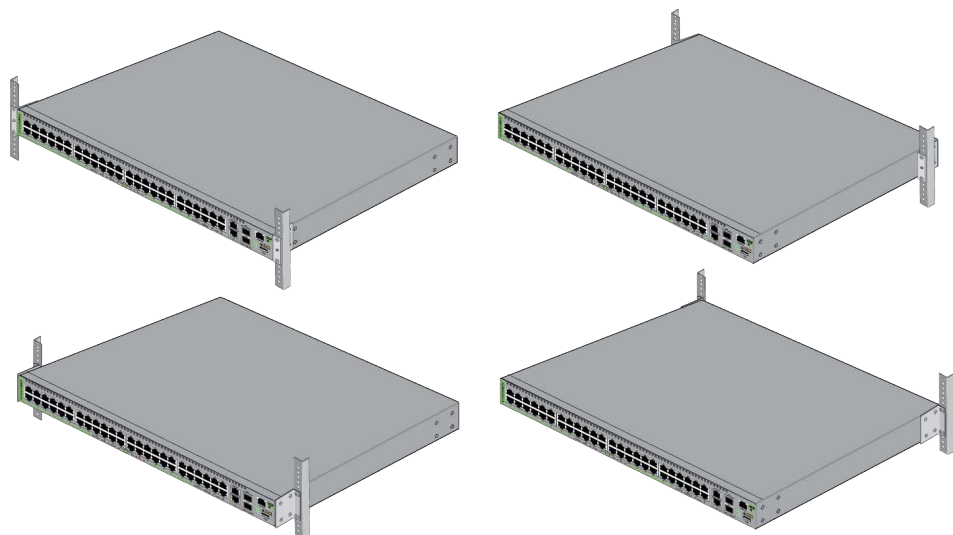

Figure 44. Equipment Rack Bracket Positions for the GS970EMX/52 Switch

Installing the GS970EMX/52 Switch

This section contains the procedure for installing the GS970EMX/52 Switch in a standard 19-inch equipment rack. Here are the required items:

- ❑ Two wall/equipment rack brackets (included with the switch).
- ❑ Eight M4x8mm bracket screws (included with the switch).
- ❑ Cross-head screwdriver (not provided).
- ❑ Four standard equipment rack screws (not provided).



Warning

The device is heavy. Ask for assistance before moving or lifting it to avoid injuring yourself or damaging the equipment. ⚡ E94

To install the switch in a 19-inch equipment rack, perform the following procedure:

1. Place the switch on a table.

Note

If the bumper feet are attached to the bottom of the switch, remove them with a flathead screwdriver before continuing.

2. Attach the wall/equipment rack brackets to the sides of the switch in the selected position, with the eight M4x8mm screws included with the switch. Figure 45 shows the brackets installed so that the front of the switch is flush with the front of the equipment rack.

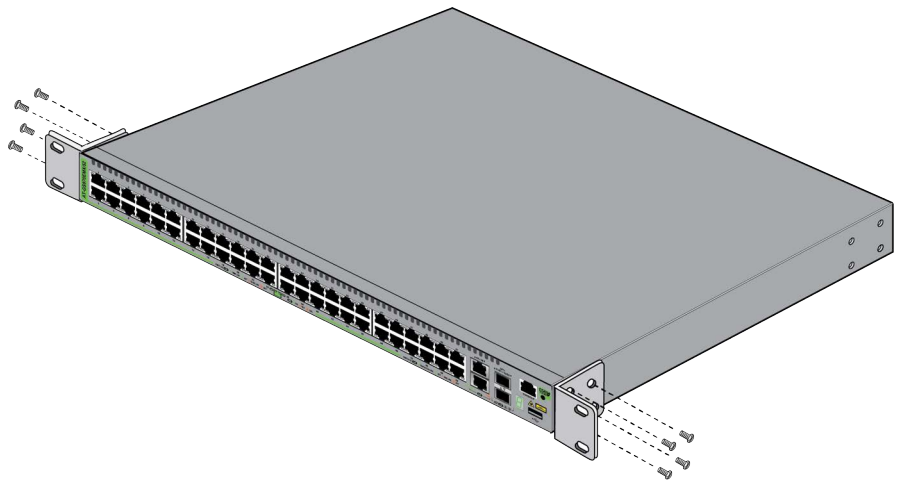

Figure 45. Attaching the Equipment Rack Brackets to the GS970EMX/52 Switch

3. Have another person hold the switch at the selected location in the equipment rack while you secure it using four standard equipment rack screws (not provided). Refer to Figure 46.

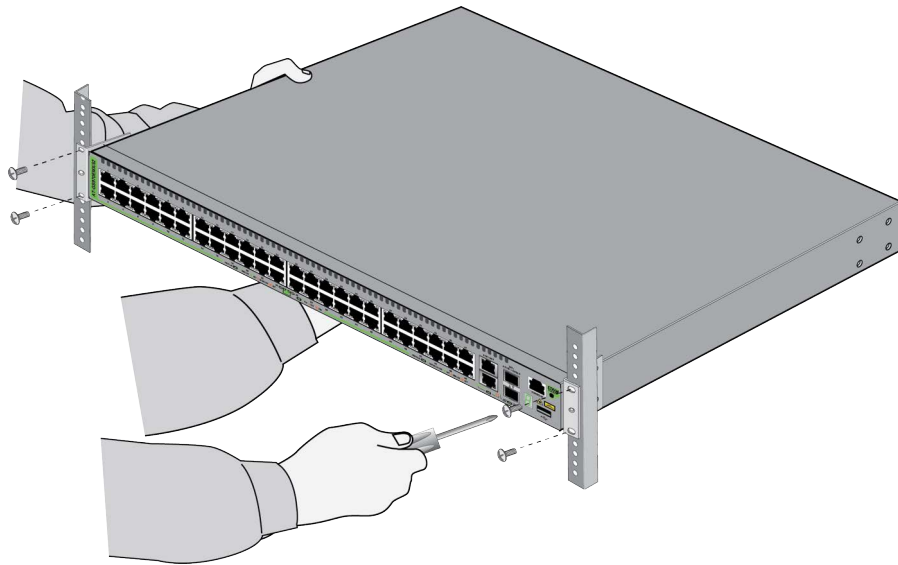

Figure 46. Securing the GS970EMX/52 Switch in a Standard 19-inch Equipment Rack

4. Go to Chapter 9, “Verifying the Switch” on page 105.

Chapter 7

Installing the GS970EMX/10 Switch on a Wall

This chapter explains how to install the GS970EMX/10 Switch on a wall with the BRKT-J23 wall brackets kit. The sections are listed here:

- “Introduction” on page 86
- “Installation Guidelines” on page 88
- “Installing the GS970EMX/10 Switch” on page 89

Introduction

Installing the GS970EMX/10 Switch on a wall requires the BRKT-J23 wall brackets kit. The kit contains two identical brackets. Refer to Figure 20 on page 56. The BRKT-J23 kit is sold separately.

You can install the switch with the front panel facing up, left or right, with two or four brackets. Figure 47 shows the switch with two brackets.

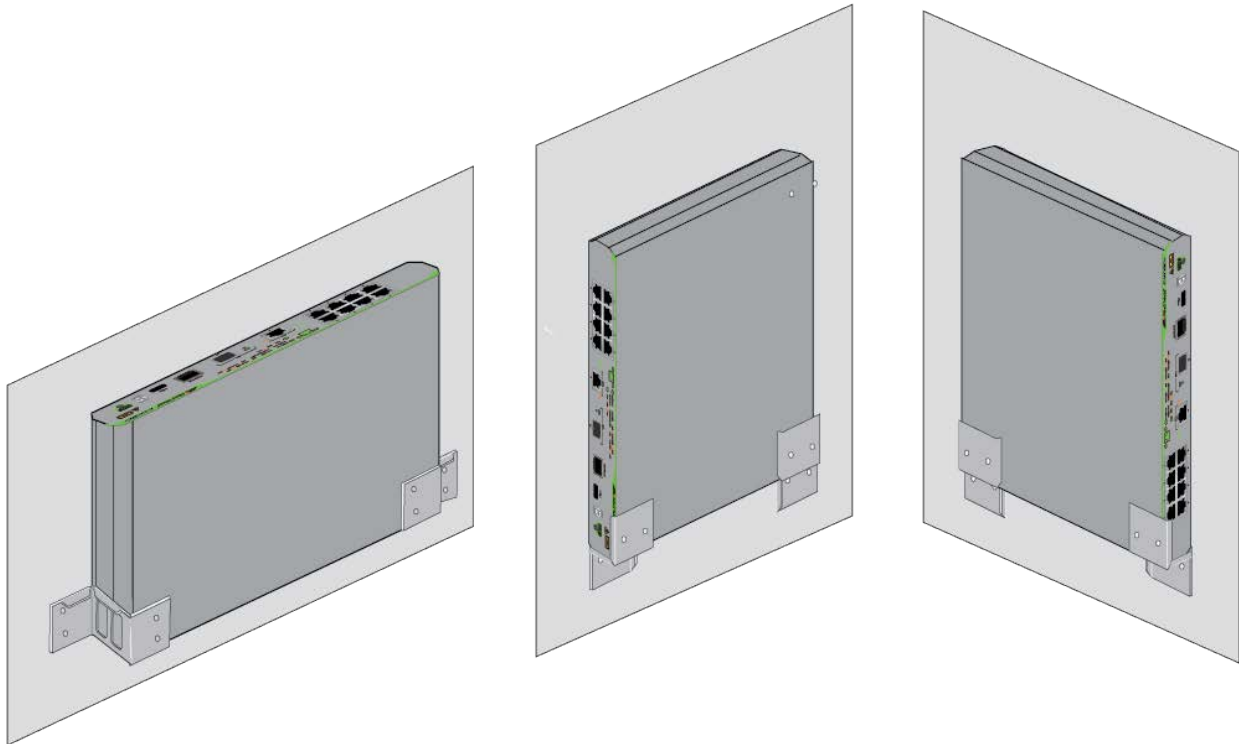

Figure 47. GS970EMX/10 Switch with Two BRKT-J23 Wall Brackets

Figure 48 shows the switch with four brackets.

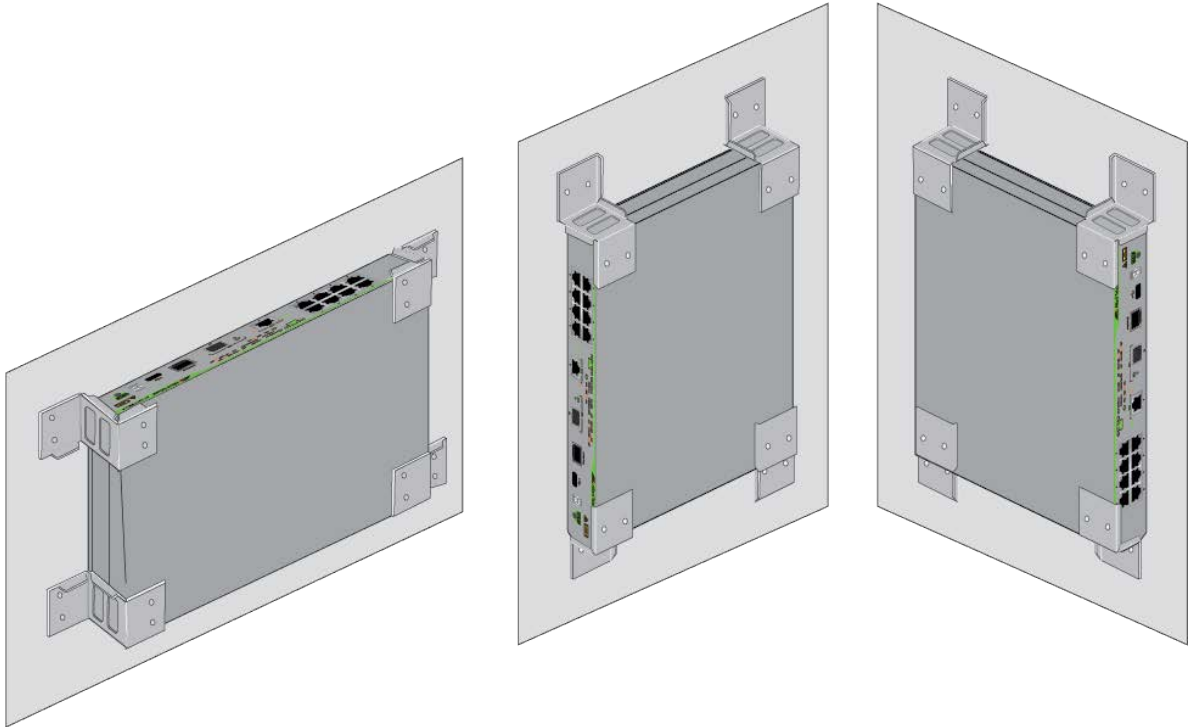

Figure 48. GS970EMX/10 Switch with Four BRKT-J23 Wall Brackets

Do not install the switch with the front panel facing down. Refer to Figure 49.

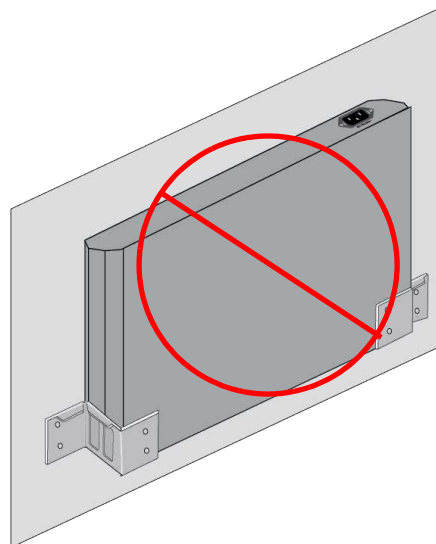

Figure 49. Unsupported Wall Installation with Front Panel Facing Down

Installation Guidelines

Here are the guidelines to installing the GS970EMX/10 Switch on a wall:

- ❑ As shown in Figure 47 on page 86 and Figure 48 on page 87, the BRKT-J23 wall brackets secure the device by its sides. Installing the brackets over the front or rear panel will block copper ports or the AC power connector.
- ❑ Installing the switch with two brackets requires one BRKT-J23 brackets kit. Installing the switch with four brackets requires two BRKT-J23 brackets kits.
- ❑ You can install the switch on a wooden or concrete wall.
- ❑ The BRKT-J23 brackets kit does not include screws or wall anchors.
- ❑ The diameter of the screw holes in the brackets is 4mm.
- ❑ You should not install the switch on only sheetrock or similar material. Sheetrock might not be strong enough to safely support the device.



Warning

The device should be installed on a wall by a qualified building contractor. Serious injury to yourself or others or damage to the equipment may result if it is not properly fastened to the wall.  E105



Warning

The device is heavy. Use both hands to lift it. You might injure yourself or damage the device if you drop it.  E94

Installing the GS970EMX/10 Switch

Here are the required tools and material for installing the GS970EMX/10 Switch on a wooden or concrete wall with the BRKT-J23 brackets:

- One or two BRKT-J23 brackets kits
- Four or eight wall screws (not provided)
- Cross-head screwdriver (not provided)
- Stud finder for a wooden wall, capable of identifying the middle of wall studs and hot electrical wiring (not provided)

Depending on the wall material these items might also be required:

- Drill for pre-drilling the holes (not provided)
- Four or eight wall anchors (not provided)



Caution

The supplied screws and anchors may not be appropriate for all wall material. A qualified building contractor should determine the appropriate hardware requirements for your wall before installing the switch. *⚡* E88

Please review “Reviewing Safety Precautions” on page 42 and “Choosing a Site for the Switch” on page 46 before performing this procedure. This procedure requires two people.



Warning

The device is heavy. Use both hands to lift it. You might injure yourself or damage the device if you drop it. *⚡* E94



Warning

The device should be installed on the wall by a qualified building contractor. Serious injury to yourself or others or damage to the equipment may result if it is not properly fastened to the wall. *⚡* E105

Depending on the selected wall location for the switch, it may be easier to verify the switch and connect the cables to the ports before mounting the device on the wall. If this is true for your installation, perform the procedures in Chapter 9, “Verifying the Switch” on page 105 and Chapter 10, “Cabling Copper and SFP+ Ports” on page 117 before performing this procedure.

To install the GS970EMX/10 Switch on a wall, perform the following procedure:

1. Place the switch on a table or desk.

Note

If the bumper feet are installed on the bottom panel of the switch, remove them before continuing.

2. Unpack the BRKT-J23 wall brackets kit and verify the contents. Refer to Figure 21 on page 56.
3. Have another person hold the switch on the wall at the selected location and orientation. Be sure to leave sufficient space from other devices or walls so that you can access the front and back panels.
4. Position the brackets on the wall and mark the bracket screw holes. Refer to Figure 50 and Figure 51 on page 91.

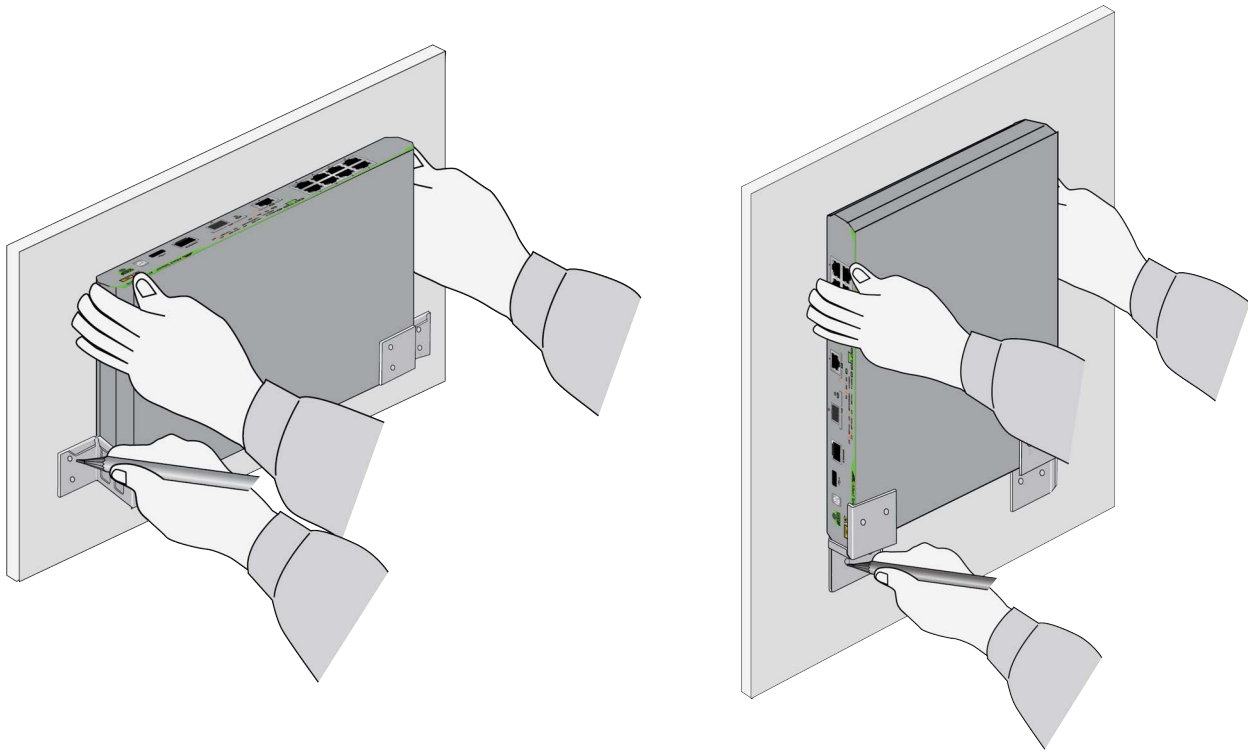

Figure 50. Marking the Screw Holes for Two BRKT-J23 Brackets

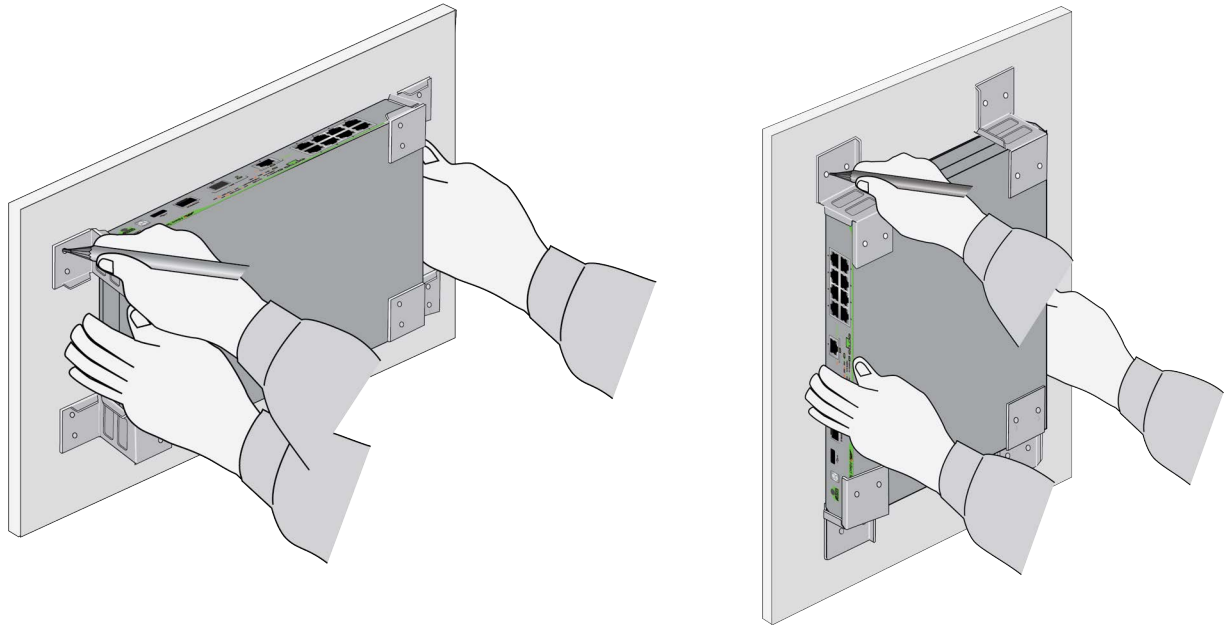

Figure 51. Marking the Screw Holes for Four BRKT-J23 Brackets

5. Place the switch and brackets on a table.
6. For a wooden wall, use a stud-finder to determine if there are any live electrical wires at the screw hole locations.
7. If required, pre-drill the screw holes on the wall. For a concrete wall, observe the following:
 - ❑ Set the drill to hammer and rotation mode to break up the concrete and clean out the hole.
 - ❑ Clean out the holes with a brush or compressed air.
8. If required, install wall anchors.
9. Attach the bottom BRKT-J23 brackets to the wall with appropriate screws. Refer to Figure 52 on page 92.

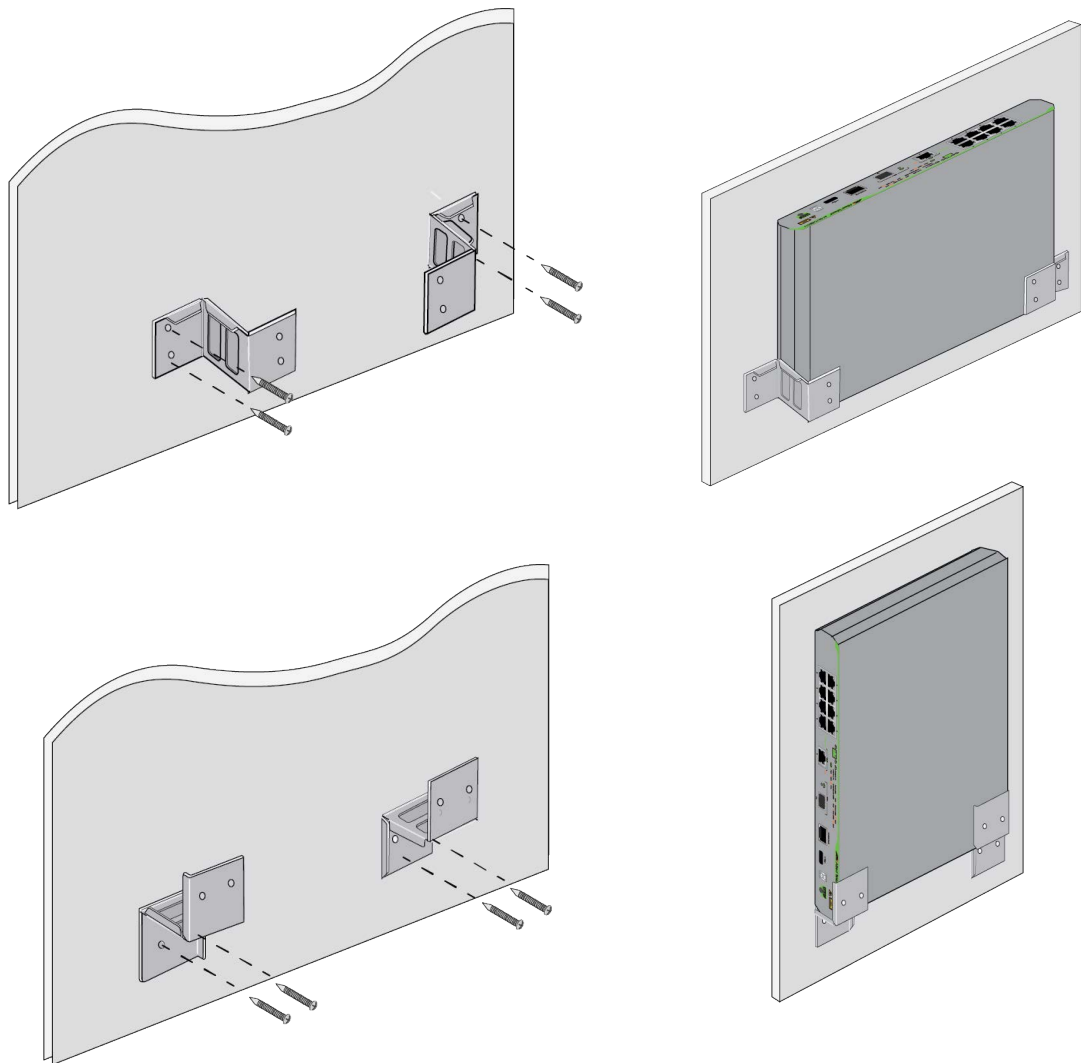

Figure 52. Attaching the Bottom BRKT-J23 Brackets to the Wall

10. Slide the switch into the BRKT-J23 brackets. Refer to Figure 53.

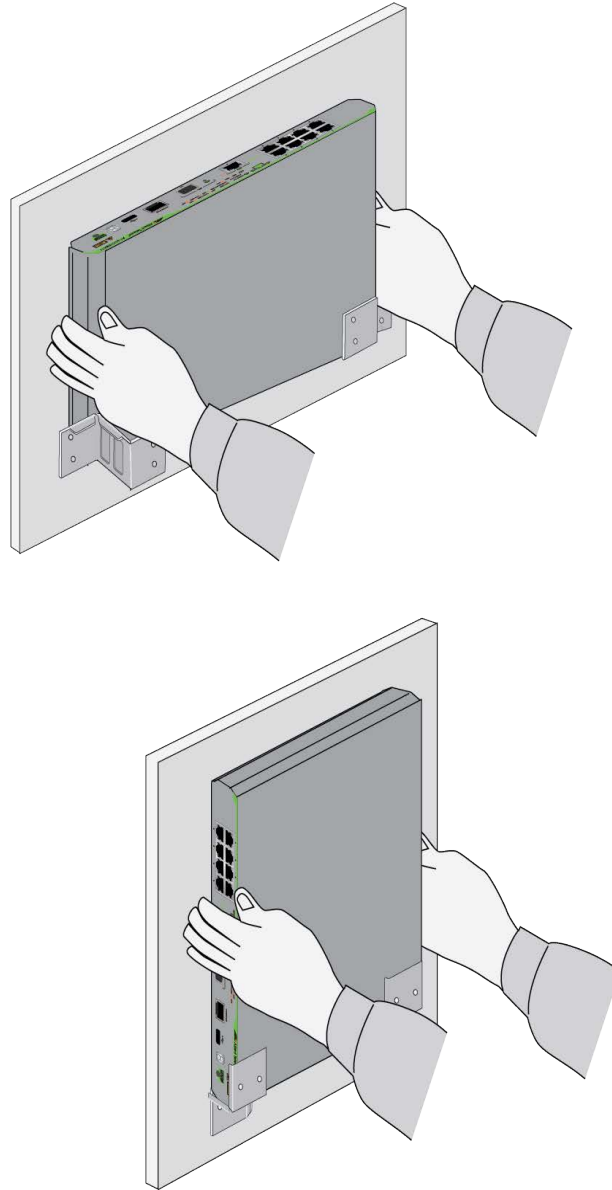

Figure 53. Sliding the Switch into the BRKT-J23 Brackets

Note

If you are installing the switch with two brackets, skip the next step and go to Chapter 9, “Verifying the Switch” on page 105. If you are installing the switch with four brackets, continue with the next step.

11. Attach the two top brackets to the wall with appropriate screws. Refer to Figure 54.

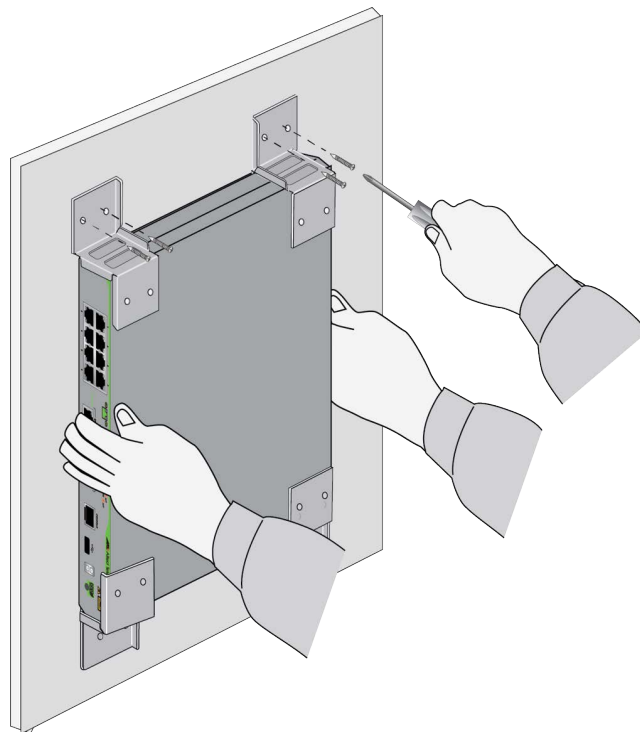
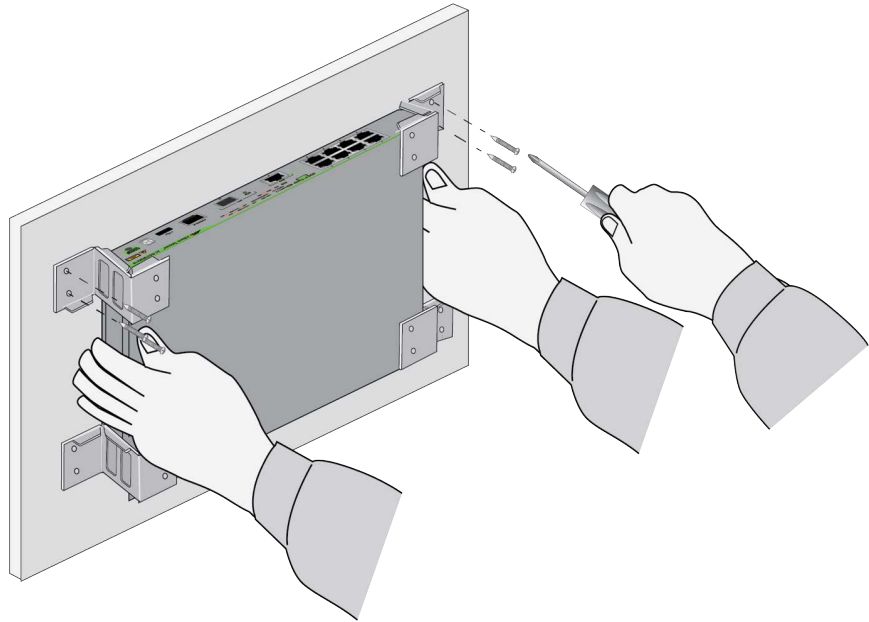

Figure 54. Attaching the Top BRKT-J23 Brackets to the Wall

12. Go to Chapter 9, "Verifying the Switch" on page 105.

Chapter 8

Installing GS970EMX/20, GS970EMX/28, and GS970EMX/52 Switches on a Wall

This chapter contains instructions for installing GS970EMX/20, GS970EMX/28, and GS970EMX/52 Switches on a wood or concrete wall. The chapter contains the following sections:

- ❑ “Installation Guidelines” on page 96
- ❑ “Plywood Base for a Wall with Wooden Studs” on page 99
- ❑ “Installing the Switch” on page 101

Installation Guidelines

The guidelines to installing GS970EMX/20, GS970EMX/28, and GS970EMX/52 Switches on a wall are listed here:

- ❑ The GS970EMX/20 and GS970EMX/28 Switches require the BRKT-J24 wall brackets kit for wall installations. The kit comes with four identical brackets. Refer to Figure 22 on page 57. The kit is sold separately.
- ❑ The GS970EMX/52 Switch is installed on a wall with the two wall/equipment rack brackets included with the unit. Refer to Figure 14 on page 50.
- ❑ You can install the switches with the front panels facing up, left or right. Refer to Figure 55.

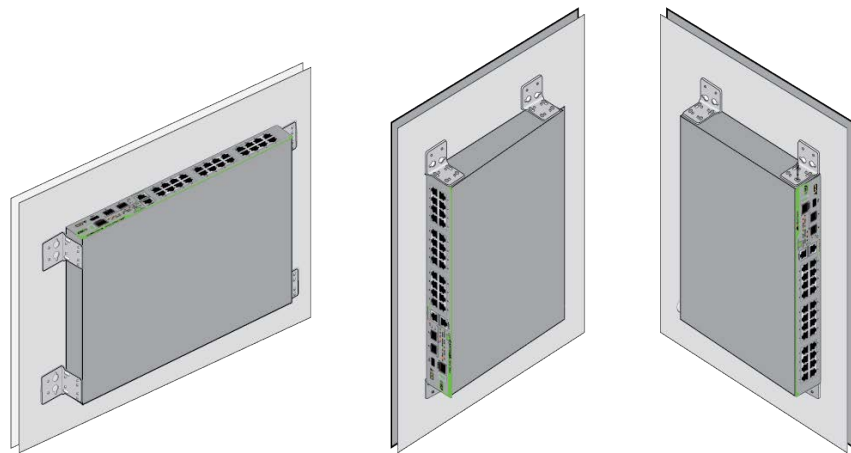

Figure 55. GS970EMX/20 and GS970EMX/28 Switches on a Wall with the BRKT-J24 Brackets Kit

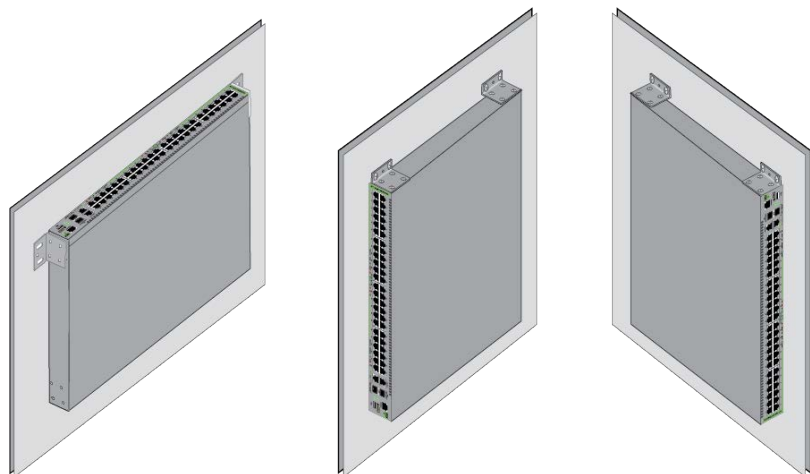

Figure 56. GS970EMX/52 Switch on a Wall

- ❑ Do not install switches with the front panels facing down. Refer to Figure 57.

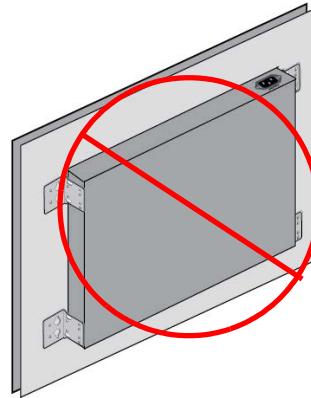

Figure 57. Unsupported Wall Installation of the GS970EMX/20, GS970EMX/28, and GS970EMX/52 Switches

Here are the guidelines to installing switches on a wall:

- ❑ You may install the switches on wooden or concrete walls.
- ❑ If you are installing the switches on a wall with wooden studs, you should install them on a plywood base. For more information, refer to “Plywood Base for a Wall with Wooden Studs” on page 99.
- ❑ You should not install the switches on a wall that has metal studs. Metal studs may not be strong enough to safely support the device.
- ❑ You should not install the switches on sheetrock or similar material. Sheetrock might not be strong enough to safely support the device.
- ❑ Attach the base to two wall studs with a minimum of four screws.
- ❑ The selected wall location should provide sufficient space from other devices or walls so that you can access the front and back panels, and for adequate air flow for ventilation.
- ❑ For wooden walls, use a stud finder to identify the middle of studs and hot electrical wiring.



Warning

The device is heavy. Ask for assistance before moving or lifting it to avoid injuring yourself or damaging the equipment. ⚡ E94



Warning

The device should be installed on a wall by a qualified building contractor. Serious injury to yourself or others or damage to the equipment may result if it is improperly fastened to the wall. ⚡ E105

Here are the required tools and material for installing the switch on a wall:

- ❑ For GS970EMX/20 and GS970EMX/28 Switches, one BRKT-J24 wall brackets kit for each switch. The kit is sold separately.
- ❑ For the GS970EMX/52 Switch, two wall/equipment rack brackets are included with the device.
- ❑ Four wall anchors and screws (not provided) The diameter of the screw holes in the brackets is 5mm.
- ❑ Cross-head screwdriver (not provided).
- ❑ Stud finder for a wooden wall, capable of identifying the middle of wall studs and hot electrical wiring (not provided).
- ❑ Drill and 1/4-inch carbide drill bit for a concrete wall (not provided).
- ❑ Plywood base if you are installing the switch on a wall with wooden studs (not provided), Refer to “Plywood Base for a Wall with Wooden Studs” on page 99 for illustrations.
- ❑ Four screws for attaching the plywood base to the wall (not provided).

Plywood Base for a Wall with Wooden Studs

When installing the switch on a wall that has wooden studs, Allied Telesis recommends installing the device on a plywood base. (A plywood base is not required for concrete walls.) Refer to Figure 58.

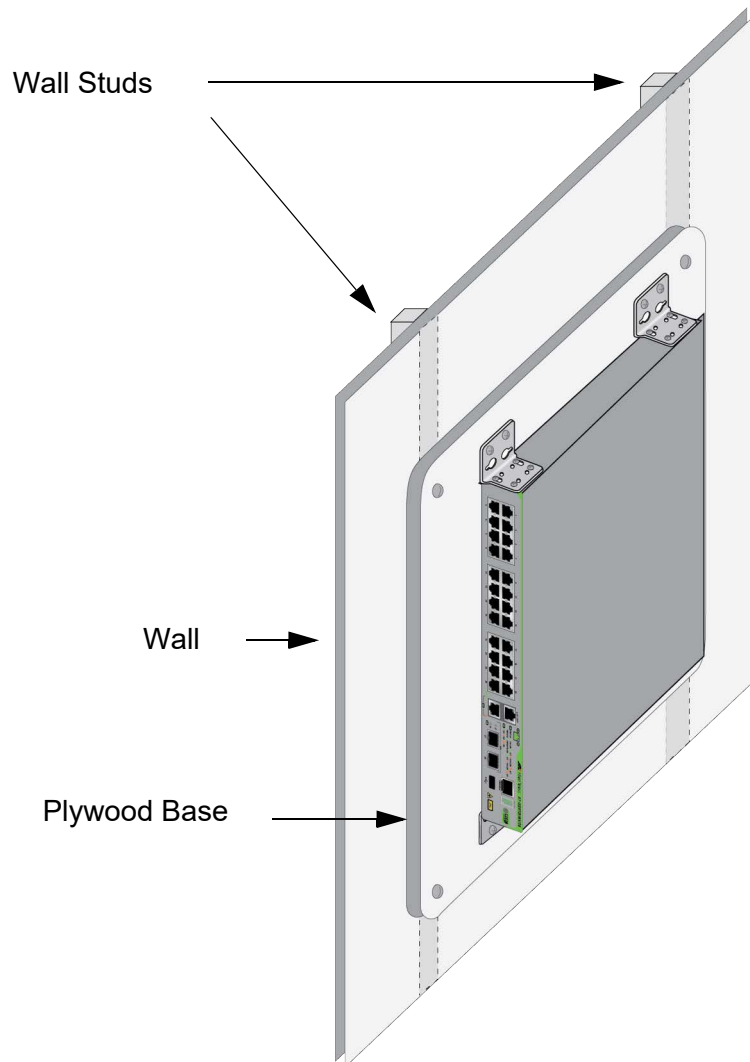

Figure 58. GS970EMX Switch on a Wall with a Plywood Base

The plywood base should be mounted on two studs in the wall. The recommended minimum dimensions of a plywood base for GS970EMX/20 and GS970EMX/28 Switches are listed here:

- ❑ Width: 55.9 centimeters (22 inches)
- ❑ Height: 50 centimeters (20 inches)
- ❑ Thickness: 2.5 centimeters (1 inch)

Recommended minimum dimensions of a plywood base for the GS970EMX/52 Switch are listed here:

- ❑ Width: 55.9 centimeters (22 inches)
- ❑ Height: 50 centimeters (22 inches)
- ❑ Thickness: 2.5 centimeters (1 inch)

The dimensions assume the wall studs are 41 centimeters (16 inches) apart. You might need to adjust the width of the base if the distance between the studs in your wall is different than the industry standard.

You should install the plywood base on the wall and then install the switch on the base. Refer to Figure 59.

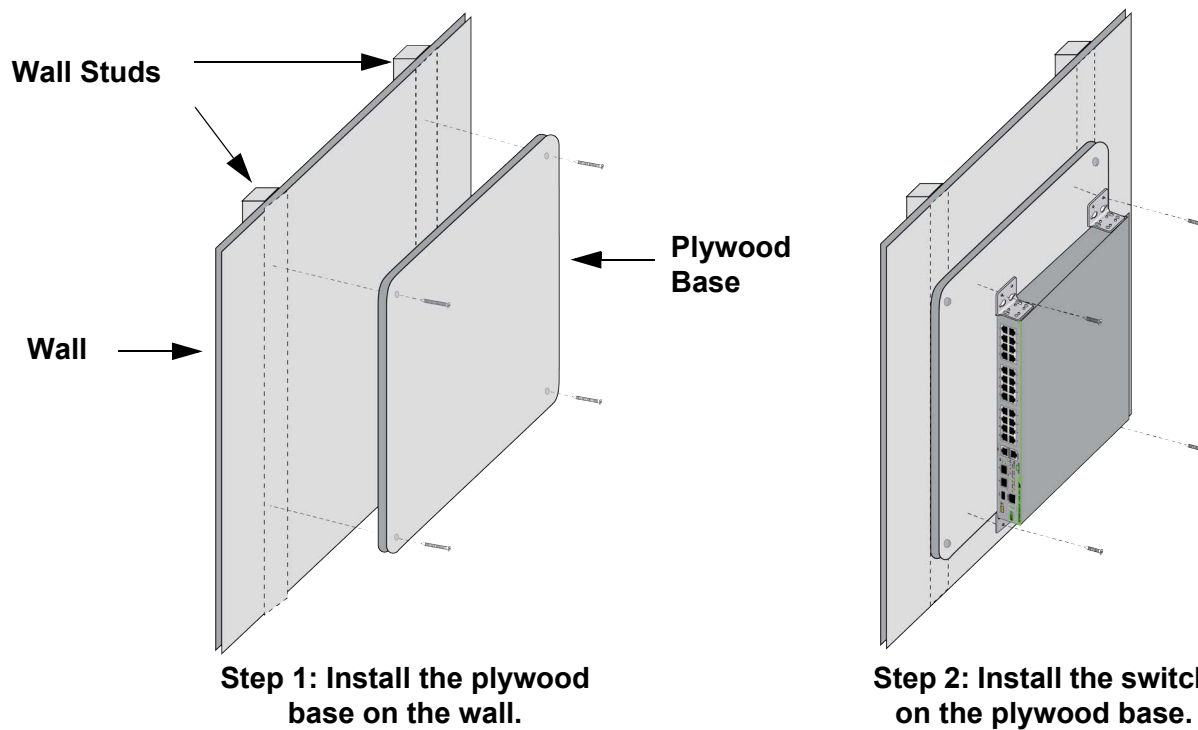

Figure 59. Steps to Installing GS970EMX Switches on a Plywood Base

Note

Consult a qualified building contractor for installation instructions for the plywood base.

Installing the Switch

This section contains the procedure for installing the switch on a wall. Review the following before performing the procedure:

- ❑ If you are installing the switch on a wall with wooden studs, the procedure assumes the plywood base is already mounted on the wall.
- ❑ Review “Reviewing Safety Precautions” on page 42 and “Choosing a Site for the Switch” on page 46 before performing this procedure.
- ❑ Allied Telesis recommends a minimum of two people for this procedure.



Warning

The device is heavy. Always ask for assistance before moving or lifting it to avoid injuring yourself or damaging the equipment.

 E94



Warning

The device should be installed on the wall by a qualified building contractor. Serious injury to yourself or others or damage to the equipment may result if it is improperly fastened to the wall.  E105

To install the switch, perform the following procedure:

1. Place the switch on a table.

Note

If the bumper feet are attached to the bottom on the switch, remove them before continuing.

2. For the GS970EMX/20 and GS970EMX/28 Switches, attach the four BRKT-J24 wall brackets to the sides of the switch, with the sixteen M4x6mm screws included in the kit. Refer to Figure 60 on page 102.

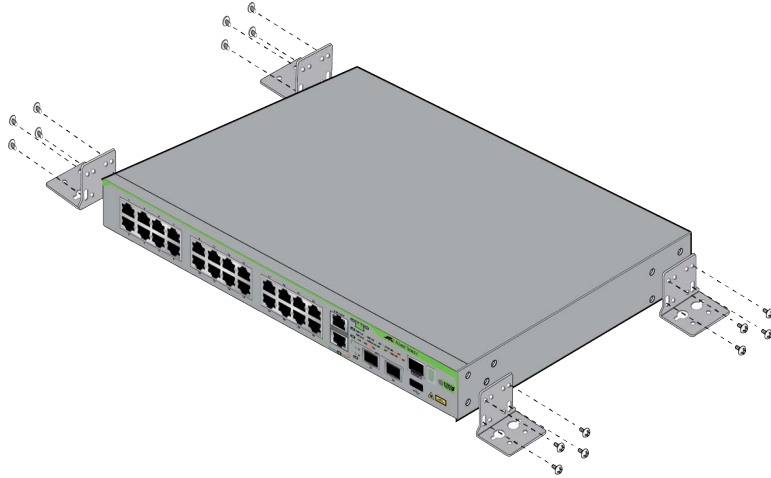

Figure 60. Attaching the BRKT-J24 Wall Brackets to the GS970EMX/20 and GS970EMX/28 Switches

3. For the GS970EMX/52 Switch, attach the two wall/equipment rack brackets to one side of the switch. Refer to Figure 61 and Figure 62 on page 103.

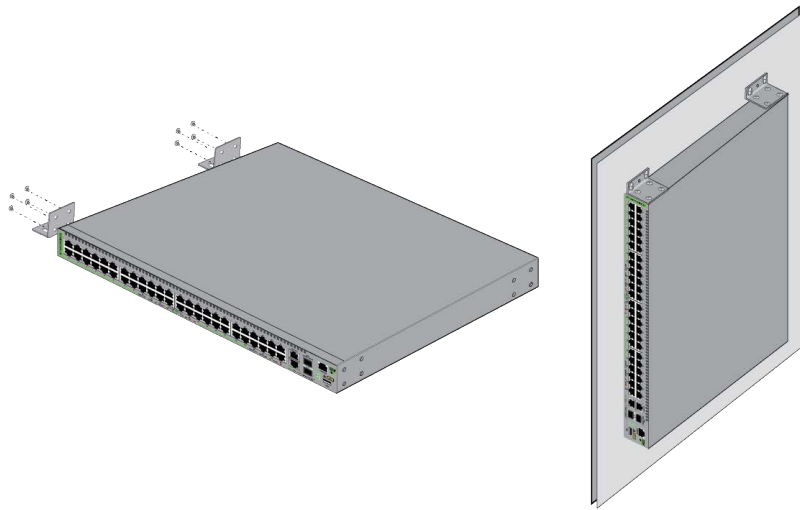

Figure 61. Attaching the Wall/Equipment Rack Brackets to the GS970EMX/52 Switch

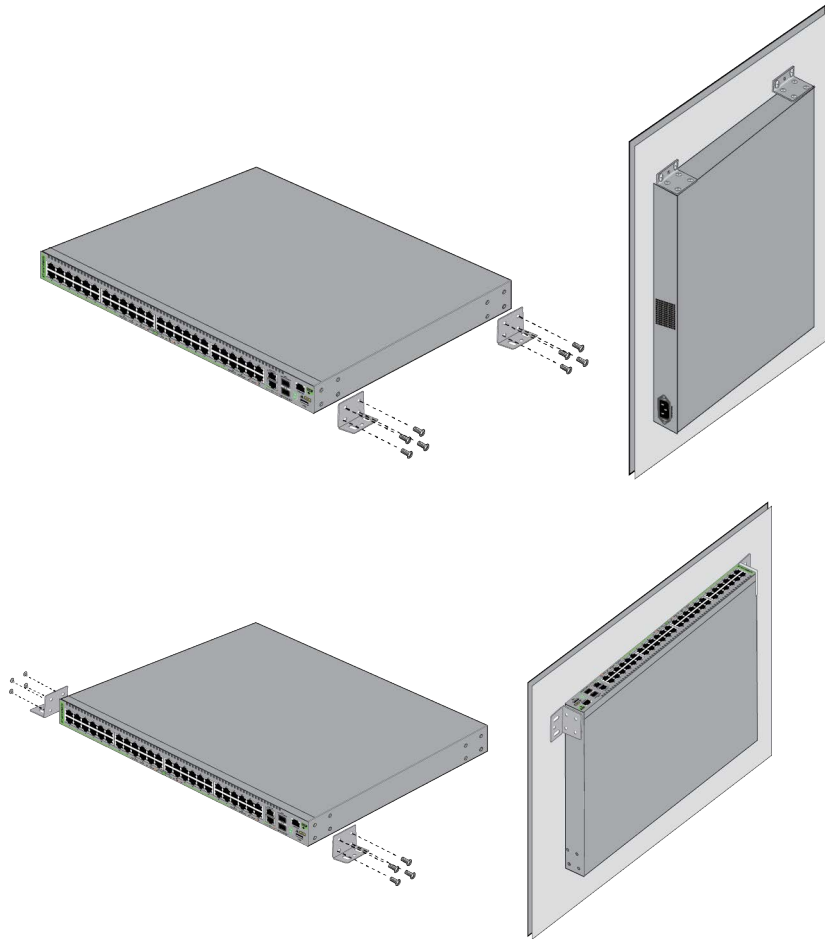

Figure 62. Attaching the Wall/Equipment Rack Brackets to the GS970EMX/52 Switch (continued)

Note

If the wall requires pre-drilled holes, such as a concrete wall, continue with the next step. Otherwise, go to step 8.

4. Have another person hold the switch on the concrete wall at the selected location for the device while you use a pencil or pen to mark the wall with the locations of the holes in the brackets. Refer to Figure 63 on page 104.

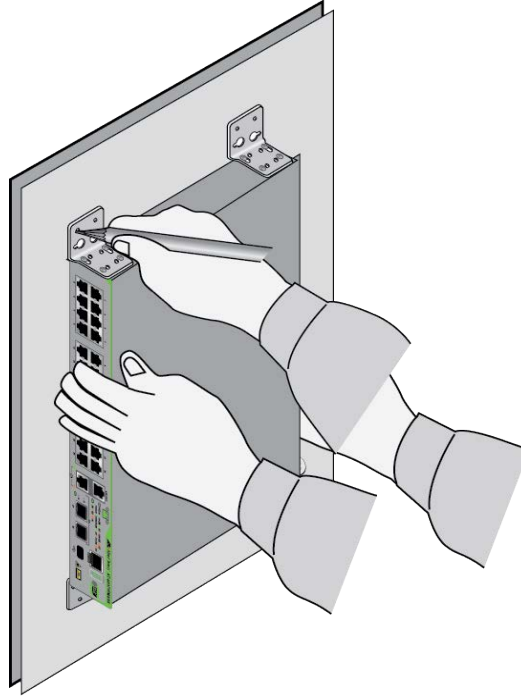

Figure 63. Marking the Locations of the Bracket Holes

5. Place the switch on a table or desk.
6. Use a drill and an appropriate drill bit, such as a 1/4" carbide drill bit for concrete walls, to pre-drill the holes you marked in step 4. Review the following guidelines:
 - ❑ For concrete walls, set the drill to hammer and rotation mode. The modes break up the concrete and clean out the hole.
 - ❑ Allied Telesis recommends cleaning out the holes with a brush or compressed air.
7. If the wall material requires anchors, insert appropriate anchors in the holes.
8. Have another person hold the switch on the wall while you secure it with appropriate screws.
9. Go to Chapter 9, "Verifying the Switch" on page 105.

Chapter 9

Verifying the Switch

The procedures in this chapter explain how to start a local management session on the switch, verify its hardware status, and disable the VCStack feature to use the switch as a standalone device. This chapter contains the following procedures:

- ❑ “Powering On the Switch” on page 106
- ❑ “Starting a Management Session” on page 108
- ❑ “Displaying the Hardware Status and Disabling VCStack” on page 113

Powering On the Switch

For AC power specifications, refer to “Power Specifications” on page 135.



Warning

Power cord is used as a disconnection device. To de-energize equipment, disconnect the power cord. ⚡ E3

Note

Pluggable Equipment. The socket outlet shall be installed near the equipment and shall be easily accessible. ⚡ E5

To power on the switch, perform the following procedure:

1. Install the power cord retaining clip on the AC power connector on the rear panel of the switch, as shown in Figure 64.

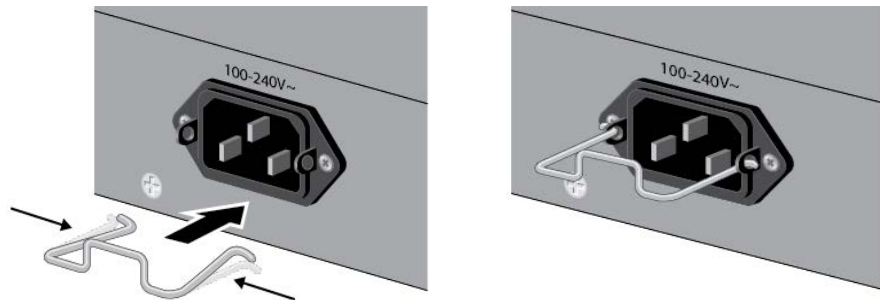

Figure 64. Installing the Power Cord Retaining Clip

2. Raise the retaining clip and connect the AC power cord to the AC power connector on the rear panel. Refer to Figure 65.

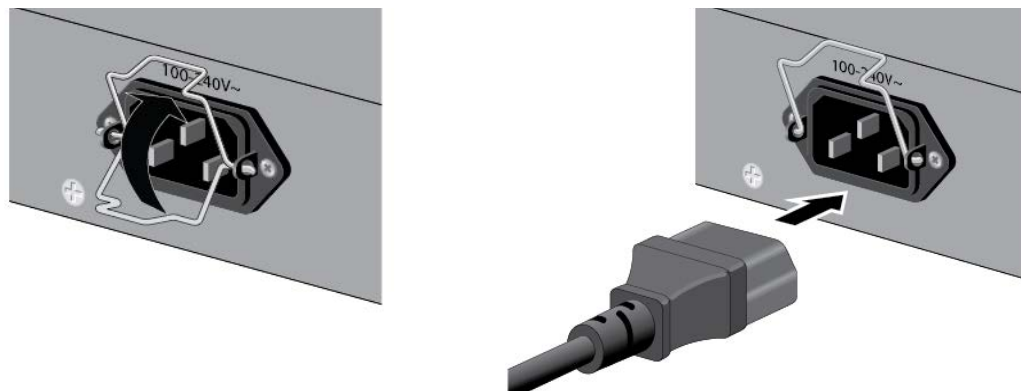

Figure 65. Connecting the AC Power Cord

3. Lower the power cord retaining clip to secure the cord to the switch. Refer to Figure 66.

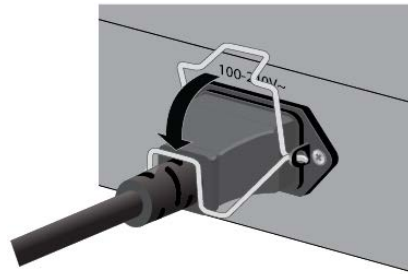

Figure 66. Lowering the Power Cord Retaining Clip

4. Connect the power cord to an appropriate AC power source. Refer to Figure 67.

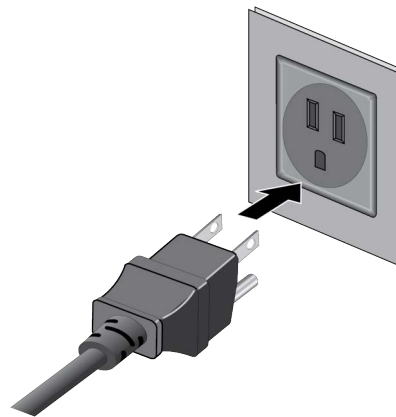

Figure 67. Connecting the Power Cord to an AC Power Source

Note

The illustration shows a North American power cord. Your power cord may be different.

5. Wait one minute for the switch to start the AlliedWare Plus management software.
6. Go to “Starting a Management Session” on page 108.

Starting a Management Session

The following procedures explain the different methods for starting the first management session on the switch:

- ❑ “Through the Console Port,” next
- ❑ “With a DHCP or DHCPv6 Server” on page 110
- ❑ “Without a DHCP or DHCPv6 Server” on page 111

Through the Console Port

This section explains how to start a local management session through the Console port on the switch. This procedure requires a terminal, computer, or laptop with an RS-232 DB-9 serial port or USB port, and a terminal emulator, such as PuTTY. The guidelines are as follows:

- ❑ Local management sessions require a management cable. If your computer has an RS-232 port, you can use the management cable supplied with the product, shown in Figure 68. The cable has a RJ-45 connector that connects to the Console port on the switch, and a female DB-9 (D-sub 9-pin) connector that connects to your computer.

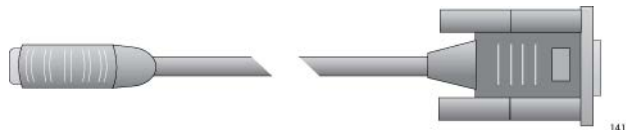

Figure 68. Management Cable Included with Switch

- ❑ If your computer has a USB port, you may need to purchase a USB-to-Serial converter that is compatible with its operating system. An example is the VT-Kit3 converter from Allied Telesis, shown in Figure 69. The VT-Kit3 converter is sold separately.



Figure 69. VT-Kit3 Management Cable

- ❑ Local management sessions do not interfere with the network operations of the switch.

- ❑ The switch does not need an IP address for local management sessions.

To start a local management session, perform the following procedure:

1. Power on the switch and wait several minutes for it to initialize the AlliedWare Plus management software.
2. Connect your computer to the Console port on the switch:
 - ❑ If your computer has an RS-232 port, connect the DB-9 connector on the supplied management cable to a DB-9 port on your computer or terminal, and the cable's RJ-45 connector to the Console port on the switch.
 - ❑ If your computer has a USB port, use a USB-to-Serial converter. To use the VT-Kit3 from Allied Telesis, connect the USB connector on the VT-Kit3 to a USB port on your computer or terminal. To connect the kit to the Console port on the switch, use a standard, straight-through Ethernet cable. Refer to Figure 70.

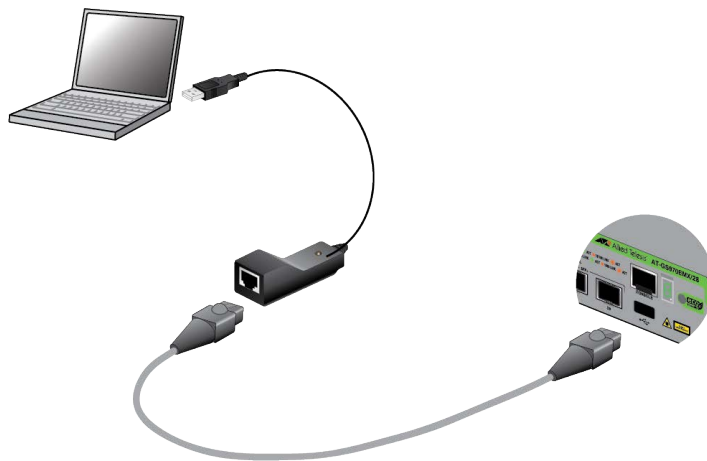

Figure 70. , Local Management with the VT-Kit3 Management Cable

3. Configure the VT-100 terminal or terminal emulation program:
 - ❑ Baud rate: 9600 bps (The baud rate of the Console port is adjustable from 1200 to 115200 bps. The default is 9600 bps.)
 - ❑ Data bits: 8
 - ❑ Parity: None
 - ❑ Stop bits: 1
 - ❑ Flow controller: None

Note

The port settings are for a DEC VT100 or ANSI terminal, or an equivalent terminal emulator program.

Note

The baud rate must be set to the default 9600 bps to configure the boot loader.

4. Press Enter. You are prompted for the name and password of the manager account.
5. Enter the default user name “manager” and password “friend”, without the quotes.

Note

User names and passwords are case sensitive.

The switch starts the local management session and displays the following prompt:

```
awplus>
```

The prompt is the User Exec mode of the command line interface.

6. Go to “Displaying the Hardware Status and Disabling VCStack” on page 113.

With a DHCP or DHCPv6 Server

This section contains the procedure for starting the first management session with the switch on a network that has a DHCP or DHCPv6 server. Review the following factory default settings for the switch when powered on for the first time:

- DHCP and DHCPv6 clients: enabled
- SSH server: enabled
- Telnet server: disabled
- Web server: enabled
- Switch ports: enabled
- VLAN membership: port-based VLAN1
- Configuration file: none (The switch creates a configuration file the first time you save the parameter settings.)

To start a management session on the switch over a network that has a DHCP or DHCPv6 server, perform the following procedure:

1. Enter the MAC address of the switch into your DHCP or DHCPv6 server so that the server assigns it an address when you power it on. The MAC address label is on the bottom panel of the switch, as shown in “Recording the Serial Number and MAC Address” on page 58. Refer to your DHCP server’s documentation for instructions.

2. Connect a single Ethernet port on the switch to your existing network.
3. Power on the switch. Wait several minutes for it to initialize the AlliedWare Plus software and obtain its IPv4 or IPv6 address from the DHCP server.
4. On your management workstation, enter the switch's assigned IP address in a Secure Shell (SSH) application or the URL field of your web browser on your workstation.
5. Press Enter. You are prompted for the name and password of the manager account.
6. Enter the default user name "manager" and password "friend", without the quotes.

Note

User names and passwords are case sensitive.

The switch starts the local management session and displays the following prompt:

```
awplus>
```

The prompt is the User Exec mode of the command line interface.

7. Go to "Displaying the Hardware Status and Disabling VCStack" on page 113.

Without a DHCP or DHCPv6 Server

This section contains the procedure for starting the first management session with the switch on a network without a DHCP or DHCPv6 server. Review the following factory default settings for the switch when powered on for the first time:

- Default IP address (no DHCP server): 169.254.42.42 (255.255.0.0)
- SSH server: enabled
- Telnet server: disabled
- Web server: enabled
- Switch ports: enabled
- VLAN membership: port-based VLAN1
- Configuration file: none (The switch creates a configuration file the first time you save its parameter settings.)

To start a management session on the switch over a network without a DHCP or DHCPv6 server, perform the following procedure:

1. Change the IP address of your workstation to 169.254.42.*n*/16 (255.255.0.0), where *n* is any number from 1 to 254, but not 42.
2. Connect the Ethernet port on your workstation to an Ethernet port on the switch.
3. Power on the switch. Wait several minutes for it to initialize the AlliedWare Plus software.
4. Enter the IP address 169.254.42.42, the switch's default IP address, in an SSH application or the URL field of the web browser on your workstation.
5. Press Enter. You are prompted for the name and password of the manager account.
6. Enter the default user name "manager" and password "friend", without the quotes.

Note

User names and passwords are case sensitive.

The switch starts the local management session and displays the following prompt:

```
awp1us>
```

The prompt is the User Exec mode of the command line interface.

7. Go to "Displaying the Hardware Status and Disabling VCStack" on page 113.

Displaying the Hardware Status and Disabling VCStack

This section contains the procedure for verifying the hardware status of the switch from a local or remote management session. It also explains how to disable the VCStack feature so that you can use the switch as a standalone device, with SFP+ ports S1 and S2 as regular Ethernet ports.

Note

The GS970EMX/10 Switch does not support the VCStack feature.

To verify the hardware operations of the switch, perform the following procedure:

1. Start a local or remote management session on the switch. Refer to “Starting a Management Session” on page 108.
2. Enter the SHOW SYSTEM ENVIRONMENT command in the User Exec or Privileged Exec mode.
3. Check the Status column. All components should have the “OK” status.
4. Do one of the following:
 - ❑ For the GS970EMX/10 Switch, which does not support VCStack, go to Chapter 10, “Cabling Copper and SFP+ Ports” on page 117.
 - ❑ For all other GS970EMX Switches, continue with the next step to disable VCStack so as to use the switch as a standalone device.



Caution

You have to reset the switch after disabling the VCStack feature. Some network traffic may be lost if the device is connected to a live network. *E89*

5. Enter the ENABLE and CONFIGURE TERMINAL commands to move to the Global Configuration mode. Refer to Figure 71.

```
awplus> enable
awplus# configure terminal
Enter configuration commands, one per line. End with CNTL/Z
awplus(config)#
```

Figure 71. Moving to the Global Configuration Mode

- To disable the VCStack feature, enter the NO STACK ENABLE command in this format:

```
no stack id enable
```

The ID parameter is the ID number of the switch, displayed on the ID LED. Replace the parameter with the number displayed by the ID LED. For example, if the Switch ID LED number is 1, the default value, you enter the command as follows:

```
awplus(config)# no stack 1 enable
```

The confirmation prompt in Figure 72 is displayed.

Warning; This will disable the stacking hardware on member-1.
Are you sure you want to continue? (y/n):

Figure 72. Confirmation Prompt for the NO STACK ENABLE Command

- Type Y to disable VCStack on the switch.
- Enter the EXIT command to return to the Privileged Exec mode. Refer to Figure 73.

```
awplus(config)# exit  
awplus#
```

Figure 73. Returning to the Privileged Exec Mode

- Enter the WRITE command to save your change in the configuration file. The switch displays the confirmation prompt in Figure 74.

```
awplus# write  
Building configuration ...  
[OK]  
awplus#
```

Figure 74. Saving the Changes with the WRITE Command

If this is the first management session, the switch automatically creates the Default.cfg file in flash memory to store your changes.

- Enter the REBOOT command to reboot the switch.
- At the confirmation prompt, type “Y” for yes.
- Wait one minute for the switch to start the AlliedWare Plus management software.

13. Examine the Switch ID LED. The ID number should be “0”, indicating that VCStack is disabled. The switch is now operating as a standalone unit, with the switch ID “1”. The S1 and S2 ports are now regular networking ports.

If the Switch ID LED on the front panel is still displaying the number “1”, repeat this procedure, being sure to save the configuration change with the WRITE command in step 9.

14. Go to Chapter 10, “Cabling Copper and SFP+ Ports” on page 117.

Chapter 10

Cabling Copper and SFP+ Ports

This chapter contains the following sections:

- ❑ “Cabling Copper Ports” on page 118
- ❑ “Guidelines to Handling SFP and SFP+ Transceivers” on page 119
- ❑ “Installing 1Gbps SFP and 10Gbps SFP+ Transceivers” on page 120
- ❑ “Installing SP10TW Direct Connect Twinax Cables in SFP+ Ports” on page 123

Cabling Copper Ports

Here are the guidelines to cabling the copper ports:

- ❑ The cable specifications are in “10/100/1000Mbps Copper Ports” on page 24 and “1/2.5/5/10Gbps Multi-Gigabit Copper Ports” on page 26.
- ❑ The connectors on the cables should fit snugly into the ports, and the tabs should lock the connectors into place.
- ❑ The default speed setting for the ports is Auto-Negotiation. This setting is appropriate for ports connected to network devices that also support Auto-Negotiation.
- ❑ Ports must be set to Auto-Negotiation, the default setting, to operate at 1000Mbps and higher speeds.
- ❑ The ports support full-duplex only at 1000Mbps and higher speeds.
- ❑ Do not attach cables to ports of static or LACP port trunks until after configuring the trunks on the switch. Otherwise, the ports might form network loops that can adversely affect network performance.

Guidelines to Handling SFP and SFP+ Transceivers

Review the following guidelines before installing SFP and SFP+ transceivers in the switch:

- ❑ Transceivers are hot-swappable. You can install them while the switch is powered on.
- ❑ For a list of supported transceivers, refer to the product's data sheet on the Allied Telesis web site.
- ❑ The operational specifications and fiber optic cable requirements of the transceivers are provided in documents included with the devices.
- ❑ You should install a transceiver before connecting its fiber optic cable.
- ❑ Fiber optic transceivers are dust sensitive. Always keep the plug in the optical bores when a fiber optic cable is not installed, or when you store the transceiver. When you do remove the plug, keep it for future use.
- ❑ Unnecessary removal and insertion of transceivers can lead to their premature failures.



Caution

Transceivers can be damaged by static electricity. Be sure to observe all standard electrostatic discharge (ESD) precautions, such as wearing an anti-static wrist strap, to avoid damaging the devices. ⚡ E92

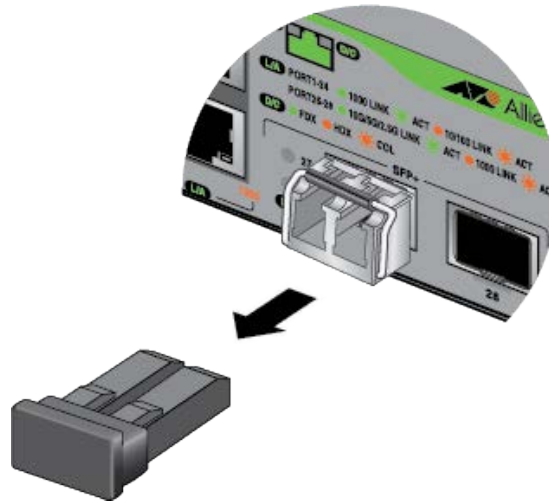

Figure 76. Removing the Dust Cover from an SFP+ Transceiver

6. Verify that the transceiver handle is in the upright position. Refer to Figure 77.

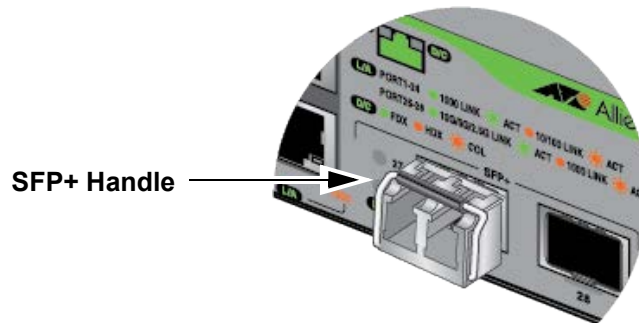

Figure 77. Positioning the SFP+ Handle in the Upright Position

7. Connect the fiber optic cable to the transceiver. Refer to Figure 78 on page 122. The cable connector should fit snugly into the port, and the tab should lock the connector into place.

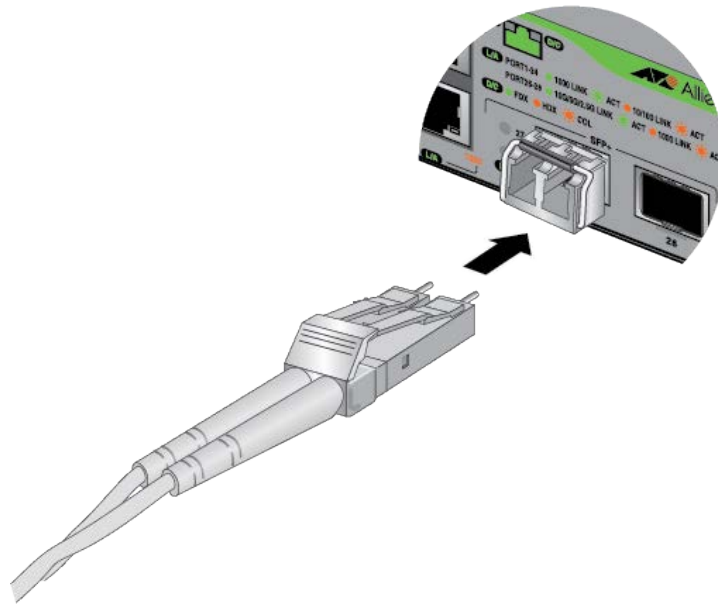

Figure 78. Connecting a Fiber Optic Cable to an SFP or SFP+ Transceiver

8. Repeat this procedure to install a second transceiver.

Note

The GS970EMX/10 Switch has only one SFP+transceiver port.

Installing SP10TW Direct Connect Twinax Cables in SFP+ Ports

The SFP+ ports support SP10TW1 and SP10TW3 direct connect twinax cables. The cables offer an economical way to add 10Gbps connections over short distances. They have SFP+ transceivers on both ends and come in lengths of one and three meters.

Note

The GS970EMX Switches do not support the seven meter SP10TW7 cable.

To install SP10TW cables, perform the following procedure:

1. Select an SFP+ port for the transceiver.
2. Remove the transceiver from its shipping container and store the packaging material in a safe location.
3. Position the transceiver with the Allied Telesis label facing up. Refer to Figure 79.

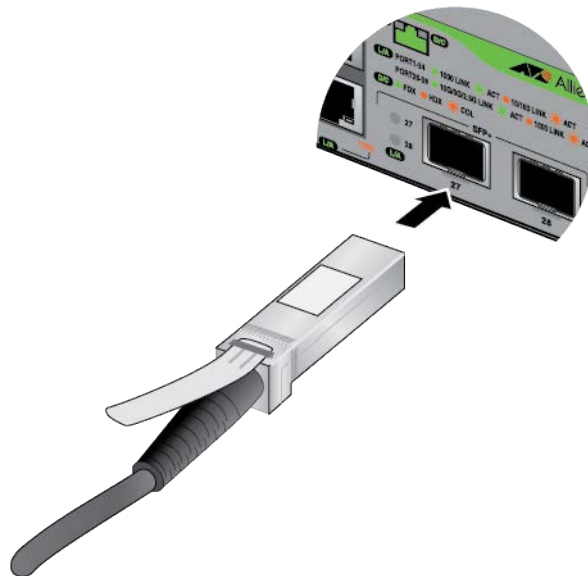

Figure 79. Installing an SP10TW Cable

4. Slide the transceiver into the port until it clicks into place.
5. Connect the other end of the cable into an SFP+ port on another network device.

6. Repeat this procedure to install a second transceiver.

Note

To remove the connector and cable from the port, gently push on the connector, pull on the release tab, and slide the connector from the switch.

Note

The GS970EMX/10 Switch has only one SFP+transceiver port.

Chapter 11

Troubleshooting

This chapter contains suggestions on troubleshooting problems with the switch.

Note

For further assistance, contact Allied Telesis Technical Support at www.alliedtelesis.com/us/en/services-support.

Problem 1: The ports are connected to network devices but the port LEDs and Switch ID LED are off.

Solutions: Try the following:

- Verify that the power cord is securely connected to the power source and the AC connector on the back panel of the switch.
- Verify that the power outlet has power by connecting another device to it.
- Try connecting the unit to another power source.
- Try a different power cord.
- Verify that the voltage from the power source is within the required levels for your region. The power requirements for the switch are listed in “Power Specifications” on page 135.
- The switch might be operating in the low power eco-friendly mode. To toggle on the LEDs, press the eco-friendly button on the front panel or enter the NO ECOFRIENDLY LED command in the command line interface.

Problem 2: A copper port is connected to an active network device, but the port’s link/activity and duplex LEDs are off.

Solutions: The port has not established a link to the network device. Try the following:

- Verify that the network device connected to the copper port is powered on and operating properly.
- Try connecting another network device to the port with a different cable. If the port is able to establish a link, then the problem is with the cable or the other network device.
- Verify that the cable does not exceed 100 meters (328 feet).

- ❑ Verify that you are using the appropriate category of cable. Cable requirements are listed in Table 1 on page 24 and Table 2 on page 26.
- ❑ Verify that the port is connected to the correct cable.

Note

Copper ports may require up to five to ten seconds to establish links to network devices.

Problem 3: The link/activity LED for an SFP or SFP+ transceiver is off.

Solutions: The fiber optic port on the transceiver has not established a link to the remote network device. Try the following:

- ❑ Verify that the remote network device connected to the fiber optic port is operating properly.
- ❑ Verify that the fiber optic cable is securely connected to the port on the transceiver and to the port on the remote network device.
- ❑ Check that the transceiver is fully inserted into the port in the switch.
- ❑ Verify that the operating specifications of the fiber optic ports on the transceiver and remote network device are compatible by referring to their documentation.
- ❑ Verify that the correct type of fiber optic cabling is being used.
- ❑ Verify that the port is connected to the correct fiber optic cable.
- ❑ Try connecting another network device to the fiber optic port using a different cable. If the port can establish a link, then the problem is with the cable or remote network device.
- ❑ Use the switch's management software to verify that the port is enabled.
- ❑ If the remote network device is a managed device, use its management firmware to determine whether its port is enabled.
- ❑ If the problem is with two BiDi (bi-directional) transceivers, refer to their data sheets to confirm that their transmission and reception frequencies are opposite each other. For example, a BiDi transceiver that transmits and receives at 1310nm and 1550nm, respectively, has to be connected to a transceiver that transmits and receives at 1550nm and 1310nm, respectively. Two BiDi transceivers that transmit and receive at the same frequencies will not establish a link.
- ❑ Test the attenuation on both directions on the fiber optic cable with a fiber optic tester to determine whether the optical signal is too weak (sensitivity) or too strong (maximum input power).

Problem 4: The switch functions intermittently.

Solutions: Check the system hardware status through the AlliedWare Plus management software:

- ❑ Use the SHOW SYSTEM ENVIRONMENT command in the Privileged Exec mode to verify that the input voltage from the power source to the switch is stable and within the approved operating range. The unit will shut down if the input voltage fluctuates above or below the approved operating range.
- ❑ Verify that the location of the switch allows for adequate airflow. The unit will shut down if it overheats.

Problem 5: The Switch ID LED on the front of the switch is flashing the letter “F.”

Solutions: The switch is overheating and may have to shut down. The switch’s location is not providing sufficient airflow for ventilation and cooling.

Appendix A

Technical Specifications

This appendix contains the following sections:

- "Physical Specifications" on page 130
- "Environmental Specifications" on page 134
- "Power Specifications" on page 135
- "Certifications" on page 137
- "RJ-45 Copper Port Pinouts" on page 139
- "RJ-45 Style Serial Console Port Pinouts" on page 140

Physical Specifications

Dimensions

Table 7 and Figure 80 and Figure 81 on page 131 provide the dimensions of the switches.

Table 7. Product Dimensions (H x W x D)

GS970EMX/10	3.8 cm x 26.3 cm x 17.9 cm (1.5 in. x 10.4 in. x 7.0 in.)
GS970EMX/20 and GS970EMX/28	4.4 cm x 34.1 cm x 23.1 cm (1.7 in. x 13.4 in. x 9.1 in.)
GS970EMX/52	4.4 cm x 44.1 cm x 32.2 cm (1.7 in. x 17.3 in. x 12.7 in.)

Width

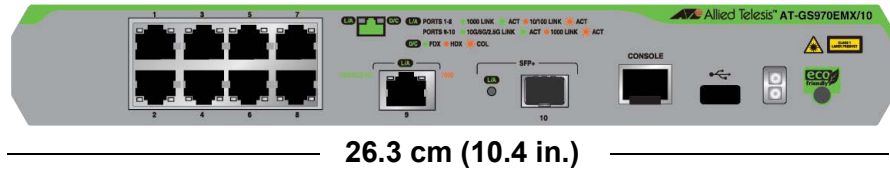

Height

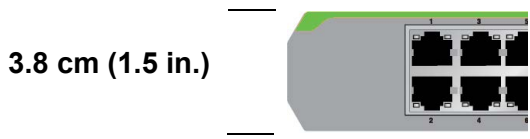

Depth

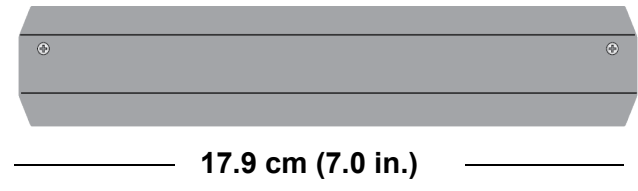
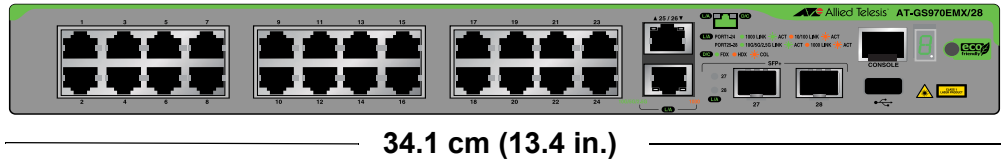

Figure 80. Dimensions of the GS970EMX/10 Switch

Width



Height

4.4 cm (1.7 in.)

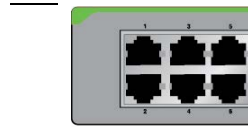

Depth

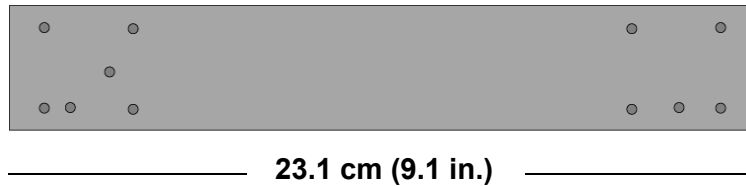
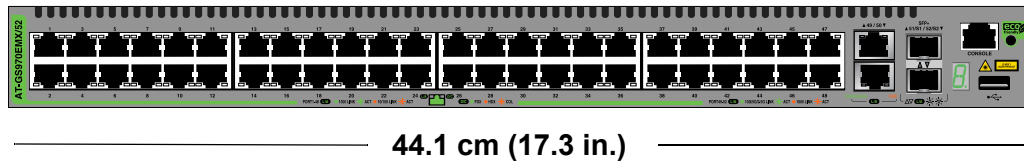

Figure 81. Dimensions of GS970EMX/20 and GS970EMX/28 Switches

Width



Height

4.4 cm (1.7 in.)

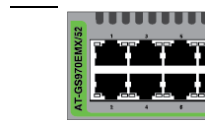

Depth

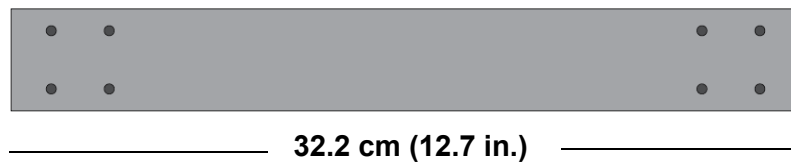

Figure 82. Dimensions of the GS970EMX/52 Switch

Weights

Table 8 lists the switch weights.

Table 8. Switch Weights

GS970EMX/10	1.6 kg (3.53 lb.)
GS970EMX/20	3.0 kg (6.61 lb.)
GS970EMX/28	3.1 kg (6.84 lb.)
GS970EMX/52	4.5 kg (9.92 lb.)

Ventilation

Table 9 lists the ventilation requirements.

Table 9. Ventilation Requirements

Recommended Minimum Ventilation on All Sides	10 cm (4.0 in)
--	----------------

Screw Hole Locations

Measurements in Figure 83 are in millimeters (mm).

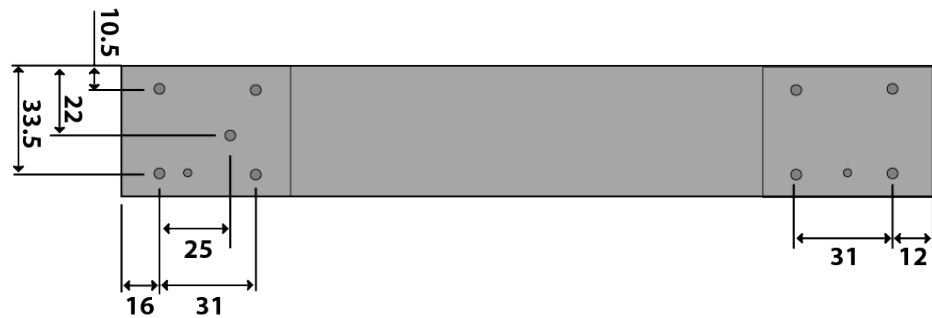

Figure 83. Bracket Screw Holes on GS970EMX/20 and GS970EMX/28 Switches

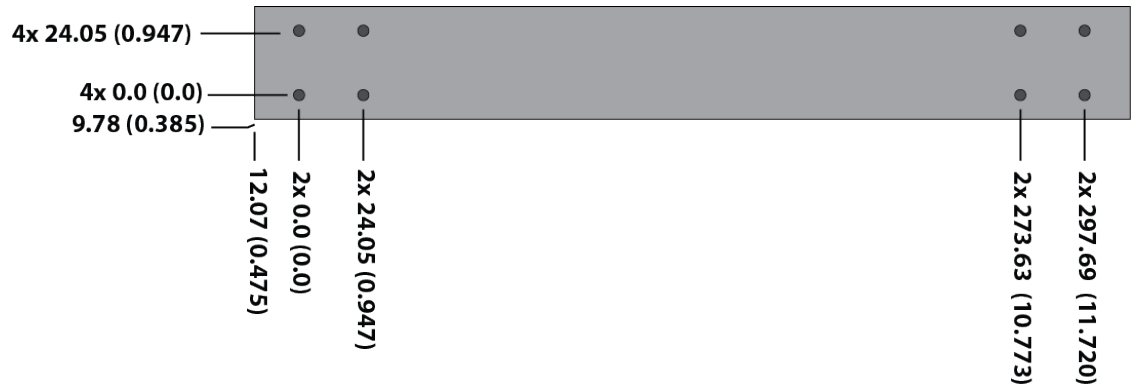

Figure 84. Bracket Screw Holes on the GS970EMX/52 Switch

Environmental Specifications

Table 10 lists the environmental specifications of the switches.

Table 10. Environmental Specifications

Operating Temperature Range of GS970EMX Series	0° C to 50° C (32° F to 122° F)
GS970EMX/52 Switch Noise Level ¹	<42 dB when outside temperature is less than 30° C (86° F) >42 dB when outside temperature is greater than 30° C (86° F)
Storage Temperature	-25° C to 70° C (-13° F to 158° F)
Operating Humidity	5% to 90% noncondensing
Storage Humidity	5% to 95% noncondensing
Maximum Operating Altitude	3,000 m (9,842 ft)
Maximum Nonoperating Altitude	4,000 m (13,100 ft)

1. The GS970EMX/52 Switch has a single fan inside the back panel. The GS970EMX/10, GS970EMX/20, and GS970EMX/28 Switches are fanless.

Power Specifications

This section contains the maximum power consumption values, input voltages, and heat dissipation values.

Maximum Power Consumptions

Table 11 lists the maximum power consumptions of the switch.

Table 11. Maximum Power Consumption

GS970EMX/10	21 watts
GS970EMX/20	28 watts
GS970EMX/28	33 watts
GS970EMX/28	52 watts

Input Voltages

Table 12 lists the input voltage of the switch.

Table 12. Input Voltages

GS970EMX/10	100-240 VAC~, 0.5A maximum, 50/60 Hz
GS970EMX/20	100-240 VAC~, 0.7A maximum, 50/60 Hz
GS970EMX/28	100-240 VAC~, 0.8A maximum, 50/60 Hz
GS970EMX/52	100-240 VAC~, 0.7A maximum, 50/60 Hz

Note

The input voltage, current, and frequency can be found on the rating label on the bottom panel of the switch.

Heat Dissipation

Table 13 lists the heat dissipation.

Table 13. Heat Dissipation

GS970EMX/10	71 BTU/hr
GS970EMX/20	96 BTU/hr
GS970EMX/28	114 BTU/hr
GS970EMX/52	181 BTU/hr

Certifications

Table 14 lists the product certificates.

Table 14. Product Certifications

Additional Certificates	CISPR Class A (Comité International Spécial des Perturbations Radioélectriques) Compliant with European and China RoHS standards
Australia/New Zealand	RCM (Regulatory Compliance Mark)
Common Criteria	NIAP (National Information Assurance Partnership)
European Economic Area (EEA)	CE (Conformité Européenne) WEEE (Waste Electrical and Electronic Equipment) RoHS (EU 1025/863) (Restriction of Hazardous Substances)
European Standards (EN)	EMC (Immunity): EN 55024, EN 55035 Laser Safety: EN 60825-1 EN 55032 Class A, EN 61000-3-2, EN 61000-3-3 Electrical Safety: EN 62368-1 (UL/ EN/IEC)
India	TEC (Telecommunications Engineering Center)
Japan	VCCI Class A (Voluntary Control Council for Interference)

Table 14. Product Certifications (Continued)

Mexico	NOM (Normas Oficiales Mexicanas)
North America	FCC Class A Laser Safety: EN 60825-1 cULus Energy Star
United Kingdom	UKCA (UK Conformity Assessment)

RJ-45 Copper Port Pinouts

Figure 85 illustrates the pin layout of the RJ-copper ports.

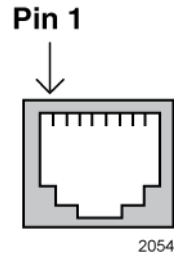

Figure 85. Pin Layout for the RJ-45 Copper Ports (Front View)

Table 15 lists the pin signals for the copper ports.

Table 15. Pin Signals for Copper Ports

Pin	10/100Mbps MDI	10/100Mbps MDI-X	1/2.5/5/10Gbps
1	TX+	RX+	Bi-directional pair A+
2	TX-	RX-	Bi-directional pair A-
3	RX+	TX+	Bi-directional pair B+
4	Not used	Not used	Bi-directional pair C+
5	Not used	Not used	Bi-directional pair C-
6	RX-	TX-	Bi-directional pair B-
7	Not used	Not used	Bi-directional pair D+
8	Not used	Not used	Bi-directional pair D-

RJ-45 Style Serial Console Port Pinouts

Table 16 lists the pin signals of the RJ-45 style serial Console port.

Table 16. RJ-45 Style Serial Console Port Pin Signals

Pin	Signal
1	Unused
2	Unused
3	Transmit Data
4	Signal Ground
5	Signal Ground
6	Receive Data
7	Unused
8	Unused
9	N/A